

ENGINEERING HANDBOOK

*Engineering Data for Copper and
Aluminum Conductor Electrical Cables*



**THE
OKONITE
COMPANY**



Okonite Cables...A higher Standard!

This booklet is designed to help engineers in the selection of conductor sizes and help in the installation of cable systems. Information from many sources has been compiled in this booklet for your convenience.

The information in Section 1 provides general conductor data. Tables are provided which give the cross sectional area, number of strands, outside diameter and weight of solid wire, class B and C strandings and Class G, H and I flexible strandings. There is also data available to calculate the ac or dc resistance of conductors at many temperatures and frequencies.

Section 2 contains the necessary tables and formulas to determine the required current for a cable circuit.

Normally, the ampacity of a cable is limited by heating but, for some circuits the voltage drop is important. For this reason, in Section 3 information on voltage regulation is included. Formulas for calculating the voltage drop are given along with a nomogram for determining the reactance of conductors.

For some applications large short circuit currents must be carried. Section 4 contains short circuit ampacities for conductors and shields that may be useful in some applications.

The purpose of shielding and the effects of grounding shields are discussed in Section 5. Tables give the voltages above which shielding should be considered. Formulas for calculating shield losses associated with multi-grounded shields are presented.

Ampacity tables and various correction factors are given in Section 6. The ampacity data applies to thermosetting (vulcanized) insulations rated at 90°C and 105°C conductor temperatures. The conditions used in calculating table values are given at the top of each table. The appropriate correction factor for any installation condition varying from those for which the tables were calculated should be used. Also included is the NFPA 70, National Electrical Code, 600 Volt ampacity table.

Cable failures may result from poor installation practices. Compliance with the procedures outlined in Section 7 may prolong the life of a cable. Information on conduit, buried, borehole and self-supporting installations is provided.

Information on high voltage dc proof testing, reel capacities, jacket materials selection and other miscellaneous information is given in Sections 8 and 9.

SECTION 1			
General Conductor Information	1 - 8		
Stranding	1 - 2		
dc Resistance	3 - 4		
ac/dc Ratios	5 - 7		
Physical & Mechanical Properties	8		
SECTION 2 General Information	9 - 11		
Motor Currents	9 - 10		
Systems Diagrams	10		
Voltage Rating	11		
Electrical Formulas	11		
SECTION 3 Voltage Regulation	12 - 12		
SECTION 4 Short Circuit Currents	14 - 15		
Conductor Currents	14		
Shielding Currents	15		
SECTION 5 Shielding	16 - 20		
Discussion	16 - 18		
Induced Voltage, Current, and loss,			
Formulas	19		
Example Problems	20		
SECTION 6 - Ampacity Tables	21 - 38		
Discussion and Correction Factors	21		
Tables	22-38		
Single Conductors			
Underground ducts	22 - 23		
Underground Direct Burial	24 - 25		
In Air	34		
In Conduit	37		
Triplexed Conductors			
Underground Ducts	26 - 27		
Underground Direct Burial	28 - 29		
In Air	35		
In Conduit	37		
		Three Conductor	
		Underground Ducts	30 - 31
		Underground Direct Burial	32 - 33
		In Air	36
		In Conduit	38
		N.E.C. Code Table	38
		SECTION 7 Installation Practices	39 - 51
		Conduit Sizes	39 - 40
		Maximum Pulling Tensions	40
		Example Problems	41
		Minimum Bending Radii	42
		Installation Procedures	43 - 45
		Borehole Cables (Safety Factor)	46
		Sag and Tension Calculations	47 - 51
		SECTION 8	
		High Voltage Proof Testing	52 - 53
		High Voltage dc Field Testing	52
		dc Field Acceptance Testing	52
		Test Limitations	52
		Test Notes	53
		Maintenance Proof Testing	53
		Frequency of Tests	53
		SECTION 9	
		Miscellaneous Information	54 - 60
		Formulas for Calculating	
		Charging Current	54
		Capacitance of Cables	54
		Insulation Resistance	54
		Jacket Materials Selection Chart	55
		Decimal Equivalents & Temperature	
		Conversion Table	56
		Equivalents of Sq. MM.	57
		Sq. In. and Circular Mils	
		Reel Capacities	
		Reusable Reels	58
		Reusable Reels	59 - 60

	Page
SECTION 1 General Conductor Information	
TABLE 1 - 1	1
TABLE 1 - 1	1
TABLE 1 - 2	2
TABLE 1 - 3	3
TABLE 1 - 4	4
TABLE 1 - 5	5
TABLE 1 - 6	6
TABLE 1 - 7	7
TABLE 1 - 8	8
TABLE 1 - 9	8
SECTION 2 General Information	
TABLE 2 - 1	9
TABLE 2 - 2	10
TABLE 2 - 3	11
SECTION 3 Voltage Regulation	
TABLE 3 - 1	13
SECTION 4 Short Circuit Currents	
TABLE 4 - 1	14
TABLE 4 - 2	15
SECTION 5 Shielding	
TABLE 5 - 1	16
TABLE 5 - 2	18
TABLE 5 - 3	19
SECTION 6 Ampacity Tables	
TABLE 6 - 1	21
TABLE 6 - 2	21
TABLE 6 - 3	21
TABLE 6 - 4	21
TABLE 6 - 5	22
TABLE 6 - 6	23
TABLE 6 - 7	23
TABLE 6 - 8	24
TABLE 6 - 9	25
TABLE 6 - 10	26
TABLE 6 - 11	27
TABLE 6 - 12	27

		Page
TABLE 6 - 13	Triplexed Cable Direct Burial - One Circuit	29
TABLE 6 - 14	Triplexed Cable Direct Burial - Two Circuits	29
TABLE 6 - 15	Three Conductor Cable Underground Ducts - One Circuit, One Cable in Duct Bank	30
TABLE 6 - 16	Three Conductor Cable Underground Ducts - Three Circuits, Three Cables in Duct Bank	31
TABLE 6 - 17	Three Conductor Cable Underground Ducts - Six Circuits, Six Cables in Duct Bank	31
TABLE 6 - 18	Three Conductor Cable Direct Burial - One Circuit, One Cable	33
TABLE 6 - 19	Three Conductor Cable Direct Burial - Two Circuits, Two Cables	33
TABLE 6 - 20	Single Conductor Cable in Air	34
TABLE 6 - 21	Three Single Conductor Cables in Air	35
TABLE 6 - 22	Three Conductor Cable in Air	36
TABLE 6 - 23	Three Single Conductor Cables in Conduit - in Air	37
TABLE 6 - 24	Three Conductor Cable - Conduit in Air - One Isolated Cable	38
TABLE 6 - 25	NEC Code Installations Ampacity at 75°C Conductor Temperature 30°C Ambient	38
SECTION 7 Installation Practices		
TABLE 7 - 1	Dimensions of Conduit	39
TABLE 7 - 2	Percent Internal Area of Conduit or Tubing	39
TABLE 7 - 3	Percent Internal Diameter of Conduit or Tubing	39
TABLE 7 - 4	Maximum Allowable Diameter (in Inches) of Individual Cables in Given Size of Conduit	39
TABLE 7 - 5	Values of e ^{fa}	40
TABLE 7 - 6	Minimum Bending Radii - Power Cables without Metallic Shielding or Armor	42
TABLE 7 - 7A	Minimum Bending Radii - Twisted Pair Instrumentation Cable	42
TABLE 7 - 7	Minimum Bending Radii - Power Cables with Metallic Shielding or Armor	42
TABLE 7 - 8	Minimum Bending Radii - Rubber Jacketed Flexible Portable Power and Control Cables used on Take-up Reels and Sheaves	42
TABLE 7 - 9	Galvanized Steel Wire - Tensile Strength - Weight - Diameters	46
TABLE 7 - 10	Sag Messenger Characteristics	47
TABLE 7 - 11	Sag Tables	49
TABLE 7 - 12	Sag Calculating Charts	50
TABLE 7 - 13	Sag Calculating Charts	51
SECTION 8 High Voltage Proof Testing		
TABLE 8 - 1	High Voltage Field Acceptance Test	52
TABLE 8 - 2	High Voltage Maintenance Test	53
TABLE 8 - 3	Frequency of Proof Testing	53
SECTION 9 Miscellaneous Information		
TABLE 9 - 1	Jacket Materials Selection Chart	55
TABLE 9 - 2	Decimal Equivalents of One Inch	56
TABLE 9 - 3	Temperature Conversion Table	56
TABLE 9 - 4	Equivalents of Sq. mm, Sq. in. and Circular Mils	57
TABLE 9 - 5	Capacity of Reusable Reels, Feet	58
TABLE 9 - 6	Dimensions and Capacities of Reusable Reels for Wires and Cables	59-60

General Conductor Information

Stranding

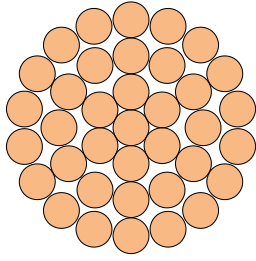

37 Strands Concentric

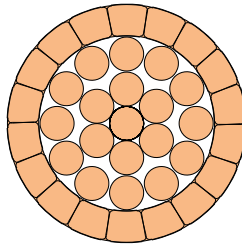

37 Strands Compressed

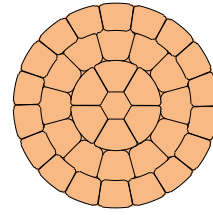

37 Strands Compact

Conductor stranding

Table 1-1

AWG	kcmil	SOLID CONDUCTORS			STRANDED CONDUCTORS								
		Diameter inch	Conductor Weight (lb. / k ft.)		Number of Strands	CLASS B			CLASS C		Conductor Weight lbs / k ft Class B & C		
			Aluminum	Copper		Compact Diameter Inch	Compressed Diameter inch	Concentric Diameter inch	No. of Strands	Diameter inch	Aluminum	Copper	
													Aluminum
24	0.404	0.0201	—	1.22	7	—	—	0.0230	—	—	—	—	1.24
22	0.640	0.0253	—	1.94	7	—	—	0.0290	—	—	—	—	1.99
20	1.02	0.0320	0.942	3.10	7	—	—	0.0360	—	—	—	—	3.16
19	1.29	0.0359	1.19	3.90	7	—	—	0.0410	—	—	—	—	3.99
18	1.62	0.0403	1.49	4.92	7	—	—	0.0460	—	—	—	—	4.99
16	2.58	0.0508	2.38	7.81	7	—	—	0.0576	19	0.0590	—	—	7.97
15	3.26	0.0571	3.01	9.87	7	—	0.0629	0.0648	19	0.0650	—	—	10.08
14	4.11	0.0641	3.78	12.4	7	—	0.0710	0.0726	19	0.0735	—	—	12.66
13	5.18	0.0720	4.79	15.7	7	—	0.0792	0.0816	19	0.0825	—	—	15.99
12	6.53	0.0808	6.01	19.8	7	—	0.0890	0.0915	19	0.0925	6.103	—	20.10
11	8.23	0.0907	7.57	24.9	7	—	0.0998	0.103	19	0.104	7.719	—	25.43
10	10.38	0.1019	9.56	31.43	7	—	0.113	0.116	19	0.117	9.725	—	32.04
9	13.09	0.1144	12.04	39.62	7	—	0.126	0.130	19	0.131	12.24	—	40.33
8	16.51	0.1285	15.20	49.98	7	0.134	0.142	0.146	19	0.148	15.50	—	51.05
7	20.82	0.1443	19.16	63.03	7	0.151	0.159	0.164	19	0.166	19.49	—	64.19
6	26.24	0.1620	24.15	79.44	7	0.169	0.178	0.184	19	0.186	24.57	—	80.95
5	33.09	0.1819	30.45	100.2	7	0.189	0.200	0.206	19	0.208	31.06	—	102.3
4	41.74	0.2043	38.41	126.3	7	0.213	0.225	0.232	19	0.234	39.10	—	128.8
3	52.62	0.2294	48.43	159.3	7	0.238	0.252	0.260	19	0.263	49.32	—	162.5
2	66.36	0.2576	61.07	200.9	7	0.268	0.283	0.292	37	0.296	62.24	—	205.0
1	83.69	0.2893	77.03	253.3	19	0.299	0.322	0.332	37	0.333	78.52	—	258.6
1/0	105.6	0.3249	97.15	319.5	19	0.336	0.362	0.373	37	0.374	99.11	—	326.5
2/0	133.1	0.3648	122.5	402.8	19	0.376	0.405	0.419	37	0.420	124.8	—	411.0
3/0	167.8	0.4096	154.4	507.8	19	0.423	0.456	0.470	37	0.471	157.4	—	518.3
4/0	211.6	0.4600	194.7	640.5	19	0.475	0.512	0.528	37	0.529	198.2	—	652.9
—	250	0.5000	—	—	37	0.520	0.558	0.575	61	0.576	234.3	—	771.9
—	300	0.5477	—	—	37	0.570	0.611	0.630	61	0.631	280.9	—	925.3
—	350	0.5916	—	—	37	0.616	0.661	0.681	61	0.681	328.3	—	1082
—	400	0.6325	—	—	37	0.659	0.706	0.728	61	0.729	375.1	—	1236
—	450	0.6708	—	—	37	0.700	0.749	0.772	61	0.773	421.9	—	1390
—	500	0.7071	—	—	37	0.736	0.789	0.813	61	0.814	468.3	—	1542
—	550	—	—	—	61	0.775	0.829	0.855	91	0.855	516.0	—	1700
—	600	—	—	—	61	0.813	0.866	0.893	91	0.893	562.6	—	1853
—	650	—	—	—	61	0.845	0.901	0.929	91	0.930	608.9	—	2006
—	700	—	—	—	61	0.877	0.935	0.964	91	0.965	655.8	—	2160
—	750	—	—	—	61	0.908	0.968	0.998	91	0.999	703.2	—	2316
—	800	—	—	—	61	0.938	1.000	1.031	91	1.032	749.6	—	2469
—	900	—	—	—	61	0.999	1.060	1.094	91	1.093	844.0	—	2780
—	1000	—	—	—	61	1.060	1.117	1.152	91	1.153	963.8	—	3086
—	1100	—	—	—	61	*1.092	1.173	1.209	127	1.210	1030	—	3393
—	1250	—	—	—	91	—	1.250	1.289	127	1.290	1172	—	3859
—	1500	—	—	—	91	—	1.370	1.412	127	1.413	1406	—	4632
—	1750	—	—	—	127	—	1.480	1.526	169	1.527	1641	—	5404
—	2000	—	—	—	127	—	1.583	1.632	169	1.632	1875	—	6176
—	2500	—	—	—	127	—	1.769	1.824	169	1.824	2370	—	7794

* The diameter listed is for a 1100 kcmil, compact round conductor, 61 wire, class A construction.

Flexible stranding

Table 1-2

Conductor Size AWG or kcmil	CLASS G				CLASS H				CLASS I			
	* Number of Wires	Diameter of Each Wire Mils	Approx. OD Inches	Weight Lbs. per 1000 Ft.	* Number of Wires	Diameter of Each Wire Mils	Approx. OD Inches	Weight Lbs. per 1000 Ft.	* Number of Wires	Diameter of Each Wire Mils	Approx. OD Inches	Weight Lbs. per 1000 Ft.
14	49	9.2	0.083	12.8								
12	49	11.6	0.104	20.3								
10	49	14.6	0.131	32.3					26	20.1	0.125	32.5
8	49	18.4	0.166	51	133	11.1	0.167	52	41	20.1	0.156	51
6	49	23.1	0.208	82	133	14.0	0.210	82	63	20.1	0.207	80
4	49	29.2	0.263	130	133	17.7	0.266	132	105	20.1	0.263	134
2	49	36.8	0.331	207	259	16.0	0.335	210	161	20.1	0.319	205
1	133	25.1	0.377	264	259	18.0	0.378	266	210	20.1	0.367	267
1/0	133	28.2	0.423	334	259	20.2	0.424	334	266	20.1	0.441	342
2/0	133	31.6	0.474	419	259	22.7	0.477	422	342	20.1	0.500	439
3/0	133	35.5	0.533	529	259	25.5	0.536	533	418	20.1	0.549	537
4/0	133	39.9	0.599	668	259	28.6	0.601	670	532	20.1	0.613	683
250	259	31.1	0.653	795	427	24.2	0.653	795	637	20.1	0.682	825
300	259	34.0	0.714	945	427	26.5	0.716	953	735	20.1	0.737	955
350	259	36.8	0.773	1110	427	28.6	0.772	1110	882	20.1	0.800	1145
400	259	39.3	0.825	1265	427	30.6	0.826	1270	980	20.1	0.831	1270
500	259	43.9	0.922	1585	427	34.2	0.923	1590	1225	20.1	0.941	1590
600	427	37.5	1.013	1910	703	29.2	1.022	1920	1470	20.1	1.027	1905
750	427	41.9	1.131	2385	703	32.7	1.145	2410	1862	20.1	1.235	2435
1000	427	48.4	1.307	3180	703	37.7	1.320	3205	2527	20.1	1.427	3305
1250	427	54.1	1.461	3975	703	42.2	1.477	4015	3059	20.1	1.564	4000
1500	427	59.3	1.601	4775	703	46.2	1.617	4815	3724	20.1	1.715	4875
1750	703	49.9	1.747	5620	1159	38.9	1.751	5625	4389	20.1	1.880	5745
2000	703	53.3	1.866	6415	1159	41.5	1.868	6400	4921	20.1	2.003	6440

*Per ICEA S-75-381

Specifications applying to conductors

COPPER CONDUCTORS	ALUMINUM CONDUCTORS
ASTM B-3 Soft or Annealed Copper ASTM B-5 Electrical Grade Copper ASTM B-8 Class A, B, C or D Stranded ASTM B-33 Soft or Annealed Tin Coated ASTM B-496 Compact Round Stranded ASTM B-784 Modified Concentric Lay Stranded ASTM B-787 19 Wire Combination Unilay ASTM B-835 Compact Round Stranded Single Input Wire ASTM B-902 Compressed Round Stranded Single Input Wire	ASTM B-230 Electrical Grade Aluminum 1350-H19 ASTM B-231 Class A, B, C or D Stranded 1350 Aluminum ASTM B-233 Electrical Grade 1350 Aluminum Drawing Stock ASTM B-400 Compact Round Stranded 1350 Aluminum ASTM B-609 Annealed and Intermediate Temper EG 1350 Aluminum ASTM B-786 19 Wire Combination Unilay 1350 Aluminum ASTM B-800 8000 Series Aluminum Alloy Annealed and Intermediate Temper ASTM B-801 8000 Series Aluminum Alloy Wires, Compact, Compressed and Concentric Class A, B, C, and D Stranded ASTM B-836 Compact Round Stranded Single Input Wire ASTM B-901 Compressed Round Stranded Single Input Wire

FLEXIBLE COPPER CONDUCTORS
B-172 Rope-Lay Stranded Conductors having Bunch-Stranded Members B-173 Rope-Lay Stranded Conductors having Concentric-Stranded Members B-174 Bunch-Stranded Conductors

General Conductor Information

dc Resistance

Resistance in Ohms per 1000 feet per conductor at 20°C and 25°C of solid wire and class B concentric stranded copper and aluminum conductor

Table 1-3

Conductor Size, AWG or kcmil	ANNEALED UNCOATED COPPER ANNEALED ALUMINUM								ANNEALED COATED COPPER			
	Solid				Stranded Class B				Solid		Stranded Class B	
	20°C		25°C*		20°C		25°C*		20°C	25°C*	20°C	25°C*
	CU	AL	CU	AL	CU	AL	CU	AL	CU	CU	CU	CU
24	25.7	—	26.2	—	—	—	—	—	26.8	27.3	—	—
22	16.2	—	16.5	—	—	—	—	—	16.9	17.2	—	—
20	10.1	—	10.3	—	10.3	—	—	10.5	10.5	10.7	11.0	11.2
19	8.05	—	8.21	—	—	—	—	—	8.37	8.53	—	—
18	6.39	—	6.51	—	6.51	—	—	6.64	6.64	6.77	6.92	7.05
16	4.02	—	4.10	—	4.10	—	—	4.18	4.18	4.26	4.35	4.44
14	2.52	4.1400	2.57	4.22	2.57	—	—	2.62	2.62	2.68	2.68	2.73
12	1.59	2.6000	1.62	2.66	1.62	2.65	—	1.65	1.62	1.68	1.68	1.72
10	0.999	1.6400	1.02	1.67	1.02	1.67	—	1.04	1.04	1.06	1.06	1.08
9	0.792	1.3000	0.808	1.32	0.808	1.33	—	0.824	0.816	0.831	0.840	0.857
8	0.628	1.0300	0.641	1.05	0.641	1.05	—	0.654	0.646	0.659	0.666	0.679
7	0.498	0.8170	0.508	0.833	0.518	0.833	—	0.518	0.513	0.523	0.528	0.539
6	0.395	0.6480	0.403	0.661	0.403	0.661	—	0.410	0.407	0.415	0.419	0.427
5	0.313	0.5140	0.319	0.524	0.320	0.524	—	0.326	0.323	0.329	0.333	0.339
4	0.248	0.4070	0.253	0.415	0.253	0.416	—	0.259	0.256	0.261	0.264	0.269
3	0.197	0.3230	0.201	0.330	0.201	0.330	—	0.205	0.203	0.207	0.209	0.213
2	0.156	0.2560	0.159	0.261	0.159	0.262	—	0.162	0.161	0.164	0.166	0.169
1	0.124	0.2030	0.126	0.207	0.126	0.206	—	0.129	0.128	0.130	0.131	0.134
1/0	0.0982	0.1610	0.100	0.164	0.100	0.165	—	0.102	0.101	0.103	0.104	0.106
2/0	0.0779	0.1280	0.0795	0.130	0.0795	0.131	—	0.0811	0.0798	0.0814	0.0827	0.0843
3/0	0.0618	0.1010	0.0630	0.103	0.0630	0.103	—	0.0642	0.0633	0.0645	0.0656	0.0668
4/0	0.0490	0.0803	0.0500	0.082	0.0500	0.0821	—	0.0509	0.0502	0.0512	0.0515	0.0525
250	—	—	—	—	0.0423	0.0695	—	0.0431	0.0708	—	0.0440	0.0449
300	—	—	—	—	0.0353	0.0579	—	0.0360	0.0590	—	0.0367	0.0374
350	—	—	—	—	0.0302	0.0496	—	0.0308	0.0505	—	0.0314	0.0320
400	—	—	—	—	0.0264	0.0434	—	0.0270	0.0442	—	0.0272	0.0278
500	—	—	—	—	0.0212	0.0348	—	0.0216	0.0354	—	0.0218	0.0222
600	—	—	—	—	0.0176	0.0290	—	0.0180	0.0295	—	0.0184	0.0187
750	—	—	—	—	0.0141	0.0232	—	0.0144	0.0236	—	0.0145	0.0148
1000	—	—	—	—	0.0106	0.0174	—	0.0108	0.0177	—	0.0109	0.0111
1100	—	—	—	—	0.00962	0.0158	—	0.00981	0.0161	—	—	0.01020
1250	—	—	—	—	0.00846	0.0139	—	0.00863	0.0142	—	0.00871	0.00888
1500	—	—	—	—	0.00705	0.0116	—	0.00719	0.0118	—	0.00726	0.00740
1750	—	—	—	—	0.00604	0.00992	—	0.00616	0.0101	—	0.00622	0.00634
2000	—	—	—	—	0.00529	0.00869	—	0.00539	0.00885	—	0.00544	0.00555
2500	—	—	—	—	0.00427	0.00702	—	0.00436	0.00715	—	0.00440	0.00448

*NOTE: To determine resistance for temperatures other than 25°C use a multiplying factor shown on page 4.

Based on the resistance-temperature coefficient of copper of 100 percent conductivity and of aluminum 61 percent conductivity (international annealed copper standard) at 25°C and the formulas:

R₁ = Resistance at 25°C
R₂ = Resistance at desired temp. T₂
T₁ = 25°C

Copper

$$R_2 = R_1 \left[\frac{234.5 + T_2}{234.5 + T_1} \right]$$

Aluminum

$$R_2 = R_1 \left[\frac{228.1 + T_2}{228.1 + T_1} \right]$$

Example:

R dc at 75°C for 4/0 AWG uncoated copper = 0.0509 x 1.193 = .0607 ohms/1000 ft.

Resistance temperature correction factors Copper Conductors

Table 1-4

Temp. C	0	1	2	3	4	5	6	7	8	9
0	.904	.908	.911	.915	.919	.923	.927	.931	.934	.938
10	.942	.946	.950	.954	.958	.961	.965	.969	.973	.977
20	.981	.985	.988	.992	.996	1.000	1.004	1.008	1.012	1.015
30	1.019	1.023	1.027	1.031	1.035	1.039	1.042	1.046	1.050	1.054
40	1.058	1.062	1.066	1.069	1.073	1.077	1.081	1.085	1.089	1.092
50	1.096	1.100	1.104	1.108	1.111	1.115	1.119	1.123	1.127	1.131
60	1.135	1.139	1.143	1.146	1.150	1.154	1.158	1.162	1.166	1.170
70	1.173	1.177	1.181	1.185	1.189	1.193	1.197	1.200	1.204	1.208
80	1.212	1.216	1.220	1.224	1.227	1.231	1.235	1.239	1.243	1.247
90	1.250	1.254	1.258	1.262	1.266	1.270	1.274	1.277	1.281	1.285
100	1.289	1.293	1.297	1.300	1.304	1.308	1.312	1.316	1.320	1.324
110	1.328	1.331	1.335	1.339	1.343	1.347	1.351	1.354	1.358	1.362
120	1.366	1.370	1.374	1.378	1.381	1.385	1.389	1.393	1.397	1.400
130	1.405	1.408	1.412	1.416	1.420	1.424	1.428	1.432	1.435	1.439
140	1.443	1.447	1.451	1.455	1.459	1.462	1.466	1.470	1.474	1.478
150	1.482	1.480	1.489	1.493	1.497	1.500	1.505	1.509	1.513	1.516

Aluminum Conductors

Temp. C	0	1	2	3	4	5	6	7	8	9
0	.901	.905	.909	.913	.917	.921	.925	.928	.932	.936
10	.940	.944	.948	.952	.956	.960	.964	.968	.972	.976
20	.980	.984	.988	.992	.996	1.000	1.004	1.008	1.012	1.016
30	1.020	1.024	1.028	1.032	1.036	1.040	1.044	1.048	1.052	1.056
40	1.060	1.064	1.068	1.072	1.076	1.080	1.084	1.088	1.092	1.096
50	1.100	1.104	1.108	1.112	1.116	1.120	1.124	1.128	1.132	1.136
60	1.140	1.144	1.148	1.152	1.156	1.160	1.164	1.168	1.172	1.176
70	1.180	1.184	1.187	1.191	1.195	1.199	1.203	1.207	1.211	1.215
80	1.219	1.223	1.227	1.231	1.235	1.239	1.243	1.246	1.250	1.254
90	1.258	1.262	1.266	1.270	1.274	1.278	1.281	1.285	1.289	1.293
100	1.297	1.301	1.304	1.308	1.311	1.315	1.319	1.324	1.328	1.332
110	1.336	1.340	1.343	1.347	1.351	1.355	1.359	1.362	1.366	1.370
120	1.374	1.378	1.381	1.385	1.389	1.393	1.397	1.401	1.405	1.409
130	1.413	1.417	1.420	1.424	1.428	1.432	1.436	1.440	1.444	1.448
140	1.452	1.456	1.459	1.463	1.467	1.471	1.475	1.479	1.483	1.487
150	1.491	1.495	1.498	1.502	1.506	1.510	1.514	1.518	1.522	1.526

General Conductor Information

ac/dc Ratios

To determine effective 60-Hertz ac resistance, multiply dc resistance values corrected for proper temperature, by the ac/dc resistance ratio given below. These apply to the following specific conditions.

Use Columns 1 and 2 for:

- (a) Single-conductor non-metallic sheathed cables — in air or non-metallic conduit.
- (b) Single-conductor metallic-sheathed cables with sheaths insulated — in air or separate non-metallic conduits.
- (c) Multiple-conductor non-metallic sheathed cables — in air or non-metallic conduits.

Note: Columns 1 and 2 include skin effect only. For close spacing such as multi-conductor cables or several cables in the same conduit, there will be an additional apparent resistance due to proximity loss. This varies with spacing (insulation thickness) but for most purposes can be neglected without serious error.

Use Column 3 for:

- (a) Multiple-conductor metallic-sheathed cable.
- (b) Multiple-conductor non-metallic sheathed cables in metal conduit.
- (c) Two or more single-conductor non-metallic sheathed cables in same metallic conduit.

ac/dc resistance ratios for copper and aluminum conductors 60 Hertz (65°C)

Table 1 - 5

Conductor Size AWG or kcmil	1 Standard Conductor		2 Segmental Conductor		3 All Strandings	
	Copper	Aluminum	Copper	Aluminum	Copper	Aluminum
Up to 3	1.000	1.000	—	—	1.00	1.00
2 and 1	1.000	1.000	—	—	1.01	1.00
0	1.001	1.000	—	—	1.02	1.00
00	1.001	1.001	—	—	1.03	1.00
000	1.002	1.001	—	—	1.04	1.01
0000	1.004	1.001	—	—	1.05	1.01
250	1.005	1.002	—	—	1.06	1.02
300	1.006	1.003	—	—	1.07	1.02
350	1.009	1.004	—	—	1.08	1.03
400	1.011	1.005	—	—	1.10	1.04
500	1.018	1.007	—	—	1.13	1.06
600	1.025	1.010	—	—	1.16	1.08
700	1.034	1.013	—	—	1.19	1.11
750	1.039	1.015	—	—	1.21	1.12
800	1.044	1.017	—	—	—	1.14
1000	1.067	1.026	1.010	1.005	—	1.19
1100	—	1.035	—	—	—	—
1250	1.102	1.040	1.018	1.008	—	1.27
1500	1.142	1.058	1.028	1.012	—	—
1750	1.185	1.079	1.038	1.016	—	—
2000	1.233	1.100	1.052	1.020	—	—
2500	1.326	1.142	1.078	1.028	—	—

Calculate ampacity at other frequencies as follows:

- 1) Determine ac/dc ratio at required frequency from Table 1-7 after calculating value of B and K.

By formula:

$$B = \sqrt{\frac{f}{R_{dc}}} \quad \text{and} \quad K = \frac{D_c}{S}$$

where f = frequency, R_{dc} = dc resistance, ohms /1000 ft. D_c = conductor diameter, S = axial spacing of conductors in inches.

- 2) Derating factor = $\sqrt{\frac{\text{ac / dc ratio at 60 Hz}}{\text{ac / dc ratio at f}}}$

- 3) Ampacity equals 60 Hertz ampacity multiplied by the derating factor.

Conductor resistance and ampacities at high frequencies

600 Volt Rubber-Neoprene Cables — Minimum triangular spacing in air or nonmetallic conduit

Table 1-6

Conductor Size	Conductor Diameter	Cable Diameter	K	D-C Res. 75°C	400 Hertz		Ampacity Derating Factor*	800 Hertz		Ampacity Derating Factor*
					B	AC/DC		B	AC/DC	
AWG or kcmil	Inches	Inches	Stranded Copper							
14	0.073	0.21	0.35	3.14	11.3	1.00	1.00	16.0	1.00	1.00
12	.092	.23	.40	1.97	14.3	1.00	1.00	20.2	1.00	1.00
10	.116	.25	.47	1.24	18.0	1.00	1.00	25.4	1.00	1.00
8	.146	.32	.46	.780	22.7	1.00	1.00	32.0	1.00	1.00
6	.184	.39	.48	.490	28.6	1.00	1.00	40.5	1.00	1.00
4	.232	.44	.53	.310	36.0	1.00	1.00	51.0	1.05	0.98
2	.292	.50	.59	.194	45.4	1.03	.98	64.4	1.12	0.94
1	.332	.61	.55	.154	51.0	1.05	.98	72.2	1.16	0.93
1/0	.373	.65	.58	.122	57.4	1.08	.96	81.	1.25	0.89
2/0	.418	.69	.61	.097	64.5	1.15	.93	91.	1.40	0.84
3/0	.470	.75	.63	.0767	72.3	1.22	.90	102.	1.53	0.81
4/0	.528	.81	.65	.0608	81.4	1.33	.87	115.	1.70	0.77
250	.575	.92	.63	.0515	88.1	1.40	.84	125.	1.82	0.74
350	.681	1.08	.63	.0368	105	1.56	.80	148.	2.05	0.70
500	.813	1.16	.70	.0258	125	1.90	.72	177.	2.54	0.63
750	.998	1.38	.73	.0172	153	2.30	.66	216.	3.06	0.57
1000	1.152	1.54	.75	.0129	177	2.60	.62	249.	3.44	0.54

*These derating factors do not apply to cables: 1. In metallic sheath, armor or conduit. 2. Adjacent to steel structures

Copper conductor resistance and ampacities at high frequencies

Skin and Proximity Effects Solid and Concentric Stranded Round Conductors

Table 1-7

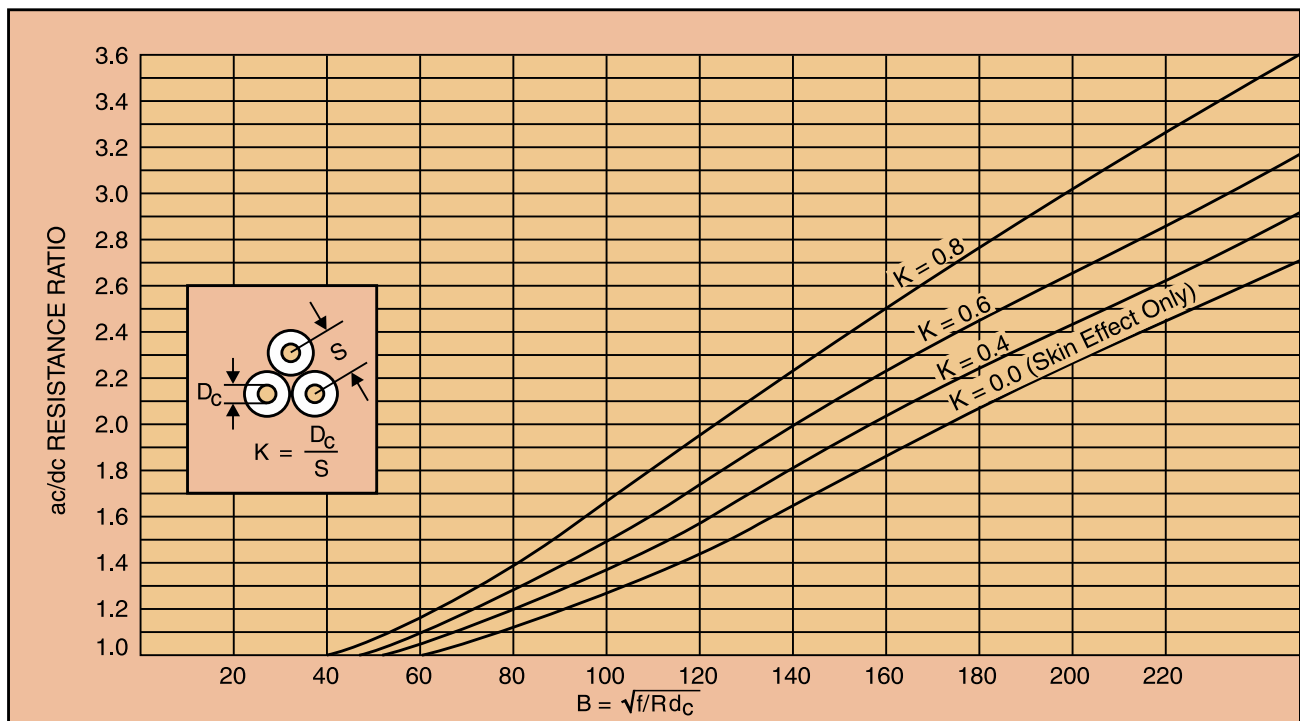

Physical & Mechanical Properties

Mechanical & Physical Properties of Conductor Materials (Average Values)

Table 1-8

	COPPER	ALUMINUM
Melting Point°F	1981	1215
Melting Point°C	1083	657
Density, lb/cu. in.	0.323	0.0977
Tensile Strength, kpsi	35	15
Thermal Conductivity @ 68°F (20°C) Btu/sq. ft./ft./hr./°F	224	135
Electrical Resistivity @ 68°F (20°C) ohm-cir mil/ft	10.37	16.96
Linear Coefficient of Expansion (68-212°F) micro in./in.°F	9.4	13.1
Specific Heat Btu/lb.°F	0.092	0.215

Breaking strength Bare copper and aluminum wire

Table 1-9

Size AWG	HARD DRAWN		MEDIUM HARD DRAWN COPPER 3/4 HARD DRAWN ALUMINUM						SOFT ANNEALED COPPER HALF HARD ALUMINUM	
	Approx. Breaking Weight in Pounds		Breaking Weight in Pounds						Approx. Breaking Weight in Pounds	
	CU	AL	Min.		Avg.		Max.		CU	AL
	CU	AL	CU	AL	CU	AL	CU	AL	CU	AL
18	85	32	68	22	72	25	77	28	49	22
16	135	54	106	32	113	38	120	42	78	33
14	213	92	167	55	178	65	189	72	124	57
12	337	144	262	87	279	103	297	113	197	90
10	529	212	410	139	439	163	468	180	314	143
9	661	262	514	175	550	206	586	226	380	180
8	826	324	644	221	689	260	735	286	480	228
6	1281	495	1010	351	1082	412	1155	454	763	361
4	1970	768	1580	545	1697	640	1814	705	1213	560
3	2439	971	1984	703	2129	826	2274	910	1530	724
2	3003	1225	2450	885	2632	1040	2815	1145	1929	912
1	3687	1542	3024	1120	3254	1315	3484	1450	2432	1150
1/0	4518	1950	3730	1410	4020	1660	4310	1825	2984	1451
2/0	5518	2460	4598	1780	4964	2100	5330	2305	3762	1831
3/0	6722	3100	5677	2240	6166	2640	6590	2900	4745	2305
4/0	8144	3900	6980	2830	7562	3320	8144	3660	5983	2910

Motor Currents

Full load currents of motors in amperes

Table 2-1

Motor Rating HP	Direct Current Motor			*Single Phase AC Motor			*INDUCTION TYPE SQUIRREL CAGE AND WOUND ROTOR				
	120V	240V	550V	115V	230V	440V	Two Phase AC Motor (4 Wire)				
	120V	240V	550V	115V	230V	440V	115V	230V	460V	575V	2300V
1/2	5.4	2.7	—	9.8	4.9	—	4.0	2.0	1.0	0.8	—
3/4	7.6	3.8	—	13.8	6.9	—	4.8	2.4	1.2	1.0	—
1	9.5	4.7	—	16.0	8.0	—	6.4	3.2	1.6	1.3	—
1 1/2	13.2	6.6	—	20.0	10.0	—	9.0	4.5	2.3	1.8	—
2	17.0	8.5	—	24.0	12.0	—	11.2	5.9	3.0	2.4	—
3	25.0	12.2	—	34.0	17.0	—	—	8.3	4.2	3.3	—
5	40.0	20.0	—	56.0	28.0	—	—	13.2	6.6	5.3	—
7 1/2	58.0	29.0	12.2	80.0	40.0	21	—	19.0	9.0	8.0	—
10	76.0	38.0	16.0	100.0	50.0	26	—	24.0	12.0	10.0	—
15	—	55.0	24.0	—	—	—	—	36.0	18.0	14.0	—
20	—	72.0	31.0	—	—	—	—	47.0	23.0	19.0	—
25	—	89.0	38.0	—	—	—	—	59.0	29.0	24.0	—
30	—	106.0	46.0	—	—	—	—	69.0	35.0	28.0	—
40	—	140.0	61.0	—	—	—	—	90.0	45.0	36.0	—
50	—	173.0	75.0	—	—	—	—	113.0	56.0	45.0	—
60	—	206.0	90.0	—	—	—	—	133.0	67.0	53.0	14
75	—	255.0	111.0	—	—	—	—	166.0	83.0	66.0	18
100	—	341.0	148.0	—	—	—	—	218.0	109.0	87.0	23
125	—	425.0	185.0	—	—	—	—	270.0	135.0	108.0	28
150	—	526.0	222.0	—	—	—	—	312.0	156.0	125.0	32
200	—	675.0	294.0	—	—	—	—	416.0	208.0	167.0	43

NOTE: In selection of cables for motor leads the regulations of the National Electric Code should be followed. The values do not take into account voltage drop and when motors are connected with long leads the voltage drop should be checked.

*The values of motor full load currents are for motors running at usual speeds and motors with normal torque characteristics. Motors built for especially low speeds or high torques may require more running current.

Motor Currents

System Diagrams

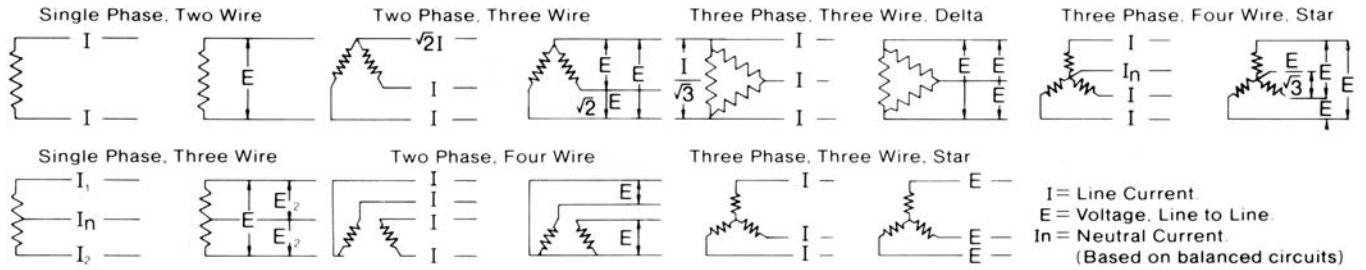

Full load currents of motors in amperes

Table 2-2

Motor Rating	INDUCTION TYPE SQUIRREL CAGE AND WOUND ROTOR					SYNCHRONOUS TYPE (†Unity Power Factor)							
	Three Phase AC Motor					Two Phase AC Motor (4 Wire)				Three Phase AC Motor			
	HP	115V	230V	460V	575V	2300V	220V	440V	550V	2300V	230V	460V	575V
1/2	4.0	2.0	1.0	0.8	—	—	—	—	—	—	—	—	—
3/4	5.6	2.8	1.4	1.1	—	—	—	—	—	—	—	—	—
1	7.2	3.6	1.8	1.4	—	—	—	—	—	—	—	—	—
1 1/2	10.4	5.2	2.6	2.1	—	—	—	—	—	—	—	—	—
2	13.6	6.8	3.4	2.7	—	—	—	—	—	—	—	—	—
3	—	9.6	4.8	3.9	—	—	—	—	—	—	—	—	—
5	—	15.2	7.6	6.1	—	—	—	—	—	—	—	—	—
7 1/2	—	22.0	11.0	9.0	—	—	—	—	—	—	—	—	—
10	—	28.0	14.0	11.0	—	—	—	—	—	—	—	—	—
15	—	42.0	21.0	17.0	—	—	—	—	—	—	—	—	—
20	—	54.0	27.0	22.0	—	—	—	—	—	—	—	—	—
25	—	68.0	34.0	27.0	—	47	24	19	—	53	26	21	—
30	—	80.0	40.0	32.0	—	56	29	23	—	63	32	26	—
40	—	104.0	52.0	41.0	—	75	37	31	—	83	41	33	—
50	—	130.0	65.0	52.0	—	94	47	38	—	104	52	42	—
60	—	154.0	77.0	62.0	16	111	56	44	11	123	61	49	12
75	—	192.0	96.0	77.0	20	140	70	57	13	155	78	62	15
100	—	248.0	124.0	99.0	26	182	93	74	17	202	101	81	20
125	—	312.0	156.0	125.0	31	228	114	93	22	253	126	101	25
150	—	360.0	180.0	144.0	37	—	137	110	26	302	151	121	30
200	—	480.0	240.0	192.0	49	—	182	145	35	400	201	161	40

NOTE: In selection of cables for motor leads the regulations of the National Electric Code should be followed. The values do not take into account voltage drop and when motors are connected with long leads the voltage drop should be checked.

† For 90 and 80% power factor the listed currents should be multiplied by 1.1 and 1.25 respectively.

Electrical Formulas

Voltage Rating

The selection of the cable insulation level to be used in a particular installation shall be made on the basis of the applicable phase to phase voltage and the general system category as outlined below:

100 Percent Level - Cables in this category may be applied where system is provided with relay protection such that ground faults will be cleared as rapidly as possible, but in any case within 1 minute. While these cables are applicable to the great majority of cable installations which are on grounded systems, they may be used also on other systems for which the application of cables is acceptable **provided the above clearing requirements are met in completely de-energizing the faulted section.

133 Percent Level - This insulation level corresponds to that formerly designated for ungrounded systems. Cables in this category may be applied in those situations

where the clearing time requirements of the 100 percent level category cannot be met, and yet there is adequate assurance that the faulted section will be de-energized in a time not exceeding 1 hour. Also they may be used when additional insulation strength over the 100 percent level category is desirable.

173 Percent Level - Cables in this category should be applied on systems where the time required to de-energize a grounded section is indefinite. Their use is recommended also for resonant grounded systems. Consult the manufacturer for insulation thickness.

**In common with other electrical equipment, the use of cables is not recommended on systems where the ratio of the zero to positive phase reactance of the system at the point of cable application lies between -1 and -40 since excessively high voltages may be encountered in the case of ground faults.

Electrical formulas for determining amperes, horsepower, kilowatts and kilovolt-amperes

Table 2-3

DESIRED DATA	ALTERNATING CURRENT			DIRECT CURRENT
	Single-Phase	Two-Phase* Four-Wire	Three-Phase	
Amperes when kva is shown	$\frac{kva \times 1000}{E}$	$\frac{kva \times 1000}{2 \times E}$	$\frac{kva \times 1000}{1.73 \times E}$	$\frac{kva \times 1000}{E}$
Amperes when kilowatts are shown	$\frac{kw \times 1000}{E \times pf}$	$\frac{kw \times 1000}{2 \times E \times pf}$	$\frac{kw \times 1000}{1.73 \times E \times pf}$	$\frac{kw \times 1000}{E}$
Amperes when horsepower is shown	$\frac{hp \times 746}{E \times \%Eff \times pf}$	$\frac{hp \times 746}{2 \times E \times \%Eff \times pf}$	$\frac{hp \times 746}{1.73 \times E \times \%Eff \times pf}$	$\frac{hp \times 746}{E \times \%Eff}$
Kilovolt-Amperes	$\frac{I \times E}{1000}$	$\frac{I \times E \times 2}{1000}$	$\frac{I \times E \times 1.73}{1000}$	$\frac{I \times E}{1000}$
Kilowatts	$\frac{I \times E \times pf}{1000}$	$\frac{1 \times E \times 2 \times pf}{1000}$	$\frac{I \times E \times 1.73 \times pf}{1000}$	$\frac{I \times E}{1000}$
Horsepower	$\frac{I \times E \times \%Eff \times pf}{746}$	$\frac{1 \times E \times 2 \times \%Eff \times pf}{746}$	$\frac{I \times E \times 1.73 \times \%Eff \times pf}{746}$	$\frac{I \times E \times \%Eff}{746}$

*In three-wire, two phase balanced circuits, the current in the common conductor is 1.41 times that in either of the other conductors.

E = volts Ø-Ø; I = amperes; % Eff = percent efficiency in decimals; pf = power factor in decimals; kva = kilovolt-ampere; hp = horsepower; kw = kilowatts

Voltage Regulation

Voltage regulation is often the limiting factor in the choice of either conductor or type of insulation. While the heat loss in the cable determines the maximum current it can safely carry without excessive deterioration, many circuits will be limited to currents lower than this in order to keep the voltage drop within permissible values. In this connection it should be remembered that the high voltage circuit should be carried as far as possible so that the secondary runs, where most of the voltage drop occurs, will be small.

The voltage drop of a feeder may be calculated from the following formulae:

$$V = \frac{100 (V_s - V_L)}{V_L}$$

V = Voltage regulation in percent

V_L = Voltage across load

V_s = Voltage at source

$$V_s = \sqrt{(V_L \cos \theta + RI)^2 + (V_L \sin \theta + XI)^2}$$

θ = is the angle by which the load current lags the voltage across the load

$\cos \theta$ = Power factor of load

R = Total a-c resistance of feeder

X = Total reactance of feeder

I = Load current

Approximate formula for voltage drop:

$$(V_s - V_L) = RI \cos \theta + XI \sin \theta$$

This above formula is satisfactory where the power factor angle is nearly the same as the impedance angle. It is exact when they are equal.

$$\text{That is: } \tan \theta = \frac{X}{R}$$

Above values apply directly for single phase lines when resistance and reactance are loop values and voltage is voltage between lines.

For 3-phase circuits, use voltage to neutral and resistance and reactance of each conductor to neutral. This gives voltage drop to neutral. To obtain voltage drop line-to-line, multiply voltage drop by $\sqrt{3}$. (The percent voltage drop is of course the same between conductors as from conductor to ground and should not be multiplied by $\sqrt{3}$.)

Example: 3 single coated copper conductors 600 volt cables in non-metallic conduit.

- Size conductor = 4/0, Awg Copper .080 insulation, .045 jacket.
- O.D. = .810"
- Voltage = $V_s = 440$ volts 3 phase
- Current = $I = 250$ amperes
- Power Factor = $\cos \theta = 0.8$
- Length = 750 ft.

AC Resistance

Per conductor = R

= .0527 ohms 1000 feet at 25°C

= .047 ohms for 750 feet at 75°C

Reactance

Per conductor = X

= .031 ohms 1000 feet (Table 3-1)

= .028 ohms for 750 feet

(including 20% for random lay)

$$V_s = \sqrt{(V_L \cos \theta + RI)^2 + (V_L \sin \theta + XI)^2}$$

$$\frac{440}{\sqrt{3}} = \sqrt{(.8V_L + .047 \times 250)^2 + (.6 V_L + .028 \times 250)^2}$$

Solving for V_L ; $V_L = 240.4$

Line-to-line voltage = $240.4 \sqrt{3} = 417$

Voltage drop = $440 - 417 = 23$ volts

$$v = \frac{440 - 417}{417} (100) = 5.52\%$$

Approximate Formula:

Voltage drop = line to neutral

= $RI \cos \theta + XI \sin \theta$

= $0.047 \times 250 \times 0.8 + 0.028 \times 250 \times 0.6$

= $9.4 + 4.2 = 13.6$

Line-to-line voltage drop = $13.6 \sqrt{3} = 23.5$ volts

Conductor Reactance

The table on page 13 shows a nomogram for determining the reactance of any solid or concentric stranded conductor. This covers spacings encountered for conduit wiring as well as for open wire circuits. Various modifications necessary for use under special conditions are covered in notes on the nomogram. The reactances shown are for 60-Hertz operation.

Where regulation is an important consideration several factors should be kept in mind in order to obtain the best operating conditions.

Open wire lines have a high reactance. This may be improved by using parallel circuits but is much further reduced by using insulated cable. Three conductors in the same conduit have a lower reactance than conductors in separate conduits.

Single conductors should not be installed in individual magnetic conduit because of the excessive reactance.

Three conductors in magnetic conduit will have a somewhat higher reactance than cables in non-magnetic conduit.

Voltage Regulation

Reactance of conductors at 60 Hz (Series inductive reactance to neutral)

Table 3-1

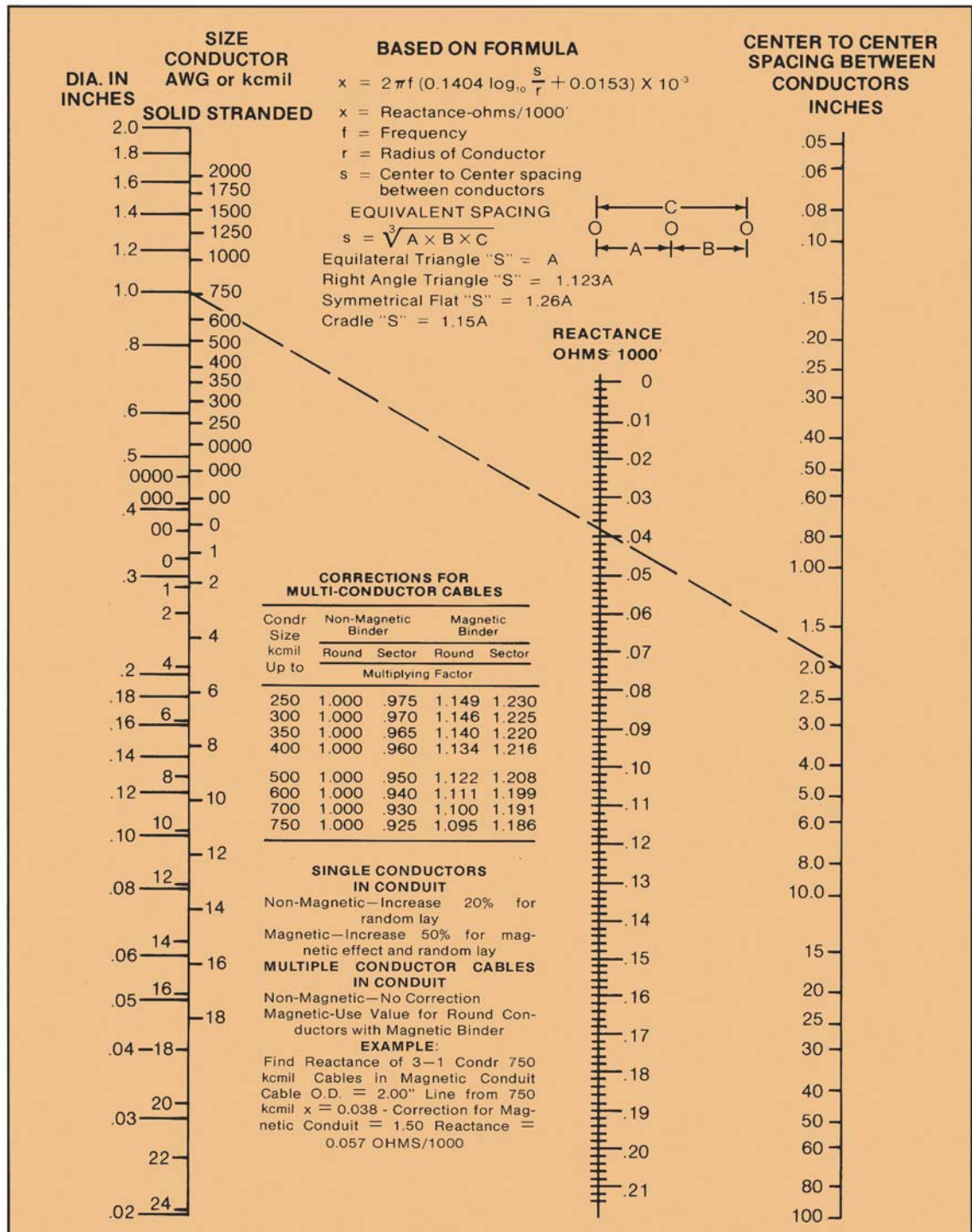

Short Circuit Currents

With the ever-increasing kva capacity of power systems, the possible short circuit currents are becoming so high that it is frequently necessary to consider the effect of these short circuits on the heating of the cables. The conductor size must be large enough to carry the short circuit current for a sufficient length of time to permit the circuit breakers to open before the conductor is heated to the point where it damages the insulation.

The chart at right shows the maximum currents to which various size copper conductors can be subjected for various times, up to 100 cycles*, without injuring the insulation. It is based on a 90°C conductor operating temperature. The maximum current for short circuit ratings for 75°C conductor temperatures and for other than 250°C may be obtained by multiplying the value obtained for T₁ = 90°C and T₂ = 250°C from chart by appropriate correction factor for other values of T₁ and T₂.

Curves Based On Formula for Copper

$$\left[\frac{I}{A} \right]^2 t = 0.0297 \log \left[\frac{T_2 + 234}{T_1 + 234} \right]$$

Where

- I = Short Circuit Current - Amperes
- A = Conductor Area - Circular mils
- t = Time of Short Circuit - Seconds
- T₁ = Operating Temperature - 90°C
- T₂ = Maximum Short Circuit Temperature - 250°C

Alternately,

$$I = A \left[\frac{0.0297 \log \left(\frac{T_2 + 234}{T_1 + 234} \right)}{t} \right]^{1/2}$$

Time increases by the square of the ratio of the conductor size.

$$t_2 = t_1 \left(\frac{A_2}{A_1} \right)^2$$

*For intermediate and long times (>100 cycles) consult IEEE Std 242 - Buff Book.

Allowable short circuit currents for insulated copper conductors*

Table 4-1

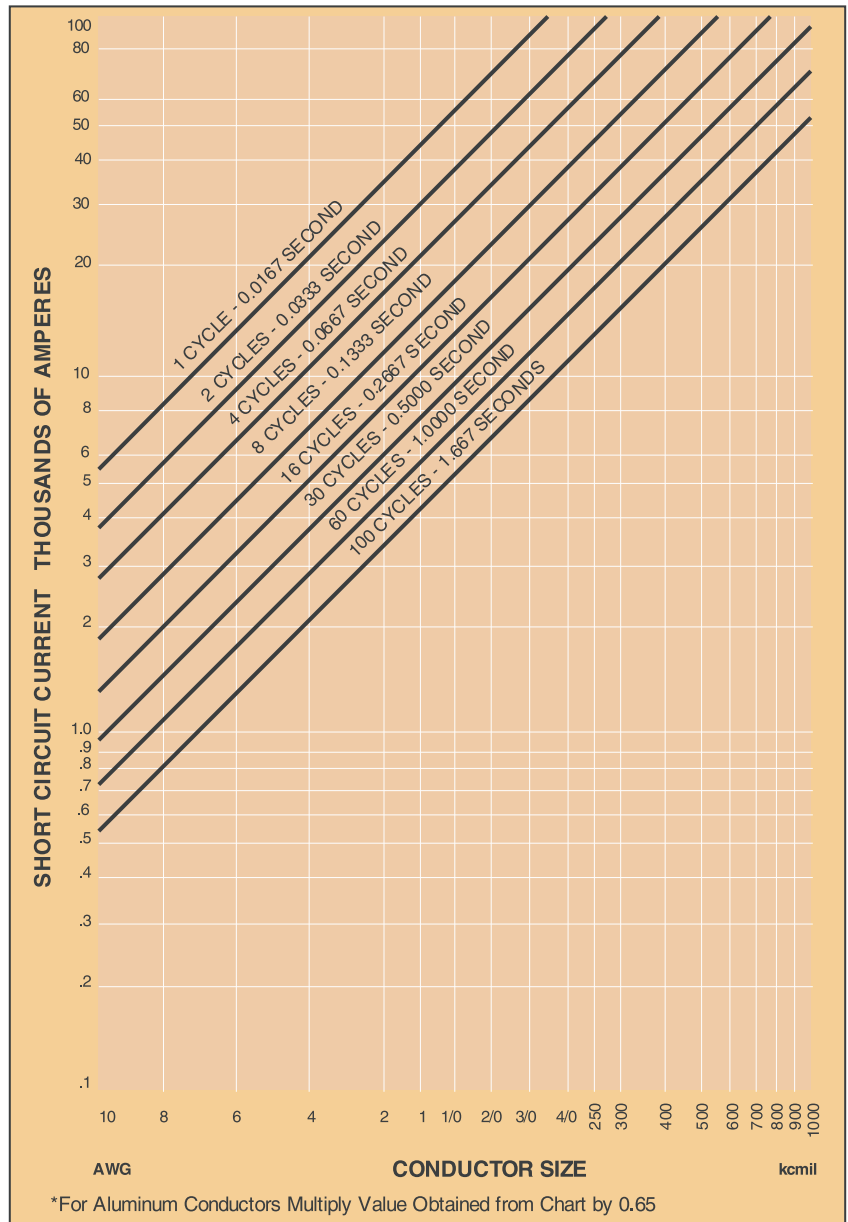

COPPER & ALUMINUM CORRECTION FACTORS FOR VARIOUS SHORT CIRCUIT TEMPERATURES				
Short Circuit Temp. (T ₂)				
	175°C	200°C	225°C	250°C
T ₁ = 75°C	0.84	0.92	0.99	1.06
T ₁ = 90°C	0.76	0.85	0.93	1.00
T ₁ = 105°C	0.68	0.78	0.87	0.94

Short Circuit Currents

Shield short circuit current formula

For short-circuit shield ampacity with a known cable shield area (or an area that can be calculated from formulas given aside), the following simplified formula may be used.

$$I = \frac{A}{\sqrt{\frac{N}{K}}}$$

Where I = Amperes
 A = Shield Area in CM
 N = Number of Cycles
 T₁ = Initial Temp. 65°C
 K = See Table Below

T MAX C	VALUES OF K		
	Cu	Al *	Pb*
150	0.193	0.083	0.0063
200	0.288	0.123	0.0094
250	0.372	0.159	0.0121
350	0.517	0.221	—

* Aluminum with 61% conductivity and Lead with 8% conductivity

NOTE: Use 200 for thermoplastic and 350 for thermosetting jackets.

For Overlapped Tape (1)	$A = 4bd_m \times \sqrt{\frac{W}{2(W-L)}}$
For Tubular Sheath	$A = 4bd_m$
For Wire Braid	$A = Nd_s^2$
For Spaced Tape	$A = 1.273 Wb$
For Flat Straps	$A = 1.273 WNb$

Where:

b = shield/strap thickness, mils
 d_m = mean diameter, mils
 d_s = wire diameter, mils
 N = number of wires/straps
 W = tape/strap width, mils
 A = area in CM
 L = lap of tape, mils

(1) Substituting various overlap values gives the following:

OVERLAP	AREA
1/2 W (50%)	4bd _m
1/4 W (25%)	3.27 bd _m
1/5 W (20%)	3.16bd _m
1/8 W (12.5%)	3.02bd _m

Permissible short circuit currents for copper shielding tape* amperes

Table 4-2

Shield Diam Inches	Effective Shield Area Circular Mils	Short Circuit Time in Number of Cycles (60 per sec.)						
		1	2	4	8	16	30	60
1/2	7,550	3,685	2,606	1,843	1,303	921	673	476
3/4	11,325	5,528	3,909	2,764	1,954	1,382	1,009	714
1	15,100	7,370	5,212	3,685	2,606	1,843	1,346	952
1 1/4	18,875	9,213	6,515	4,607	3,257	2,303	1,682	1,189
1 1/2	22,650	11,056	7,818	5,528	3,909	2,764	2,018	1,427
1 3/4	26,425	12,898	9,120	6,449	4,560	3,225	2,355	1,665
2	30,200	14,741	10,423	7,370	5,212	3,685	2,691	1,903
2 1/4	33,975	16,584	11,726	8,292	5,863	4,146	3,028	2,141
2 1/2	37,750	18,426	13,029	9,213	6,515	4,607	3,364	2,379
2 3/4	41,525	20,269	14,332	10,134	7,166	5,067	3,701	2,617
3	45,300	22,111	15,635	11,056	7,818	5,528	4,037	2,855

*Values derived from formula on page 14 where T₂ = 200°C, T₁ = 85°C, and using a 5 mil copper tape with 12.5% overlap.

Shielding should be considered for non-metallic covered cables operating at a circuit voltage above 2000 volts for single conductor cables and 5000 volts for assembled conductors with a common overall jacket.

Definition of shielding

Shielding of an electric power cable is the practice of confining the electric field of the cable to the insulation of the conductor or conductors. It is accomplished by means of strand and insulation shields.

Functions of Shielding

A strand shield is employed to preclude excessive voltage stress on voids between conductor and insulation. To be effective, it must adhere to or remain in intimate contact with the insulation under all conditions.

An insulation shield has a number of functions:

- (a) To confine the electric field within the cable.
- (b) To obtain symmetrical radial distribution of voltage stress within the dielectric, thereby minimizing the possibility of surface discharges by precluding excessive tangential and longitudinal stresses.
- (c) To protect cable connected to overhead lines or otherwise subject to induced potentials.
- (d) To limit radio interference.
- (e) To reduce the hazard of shock. If not grounded, the hazard of shock may be increased.
- (f) To provide a low impedance path to carry charging current to ground.

Use of Insulation Shielding

The use of shielding involves consideration of installation and operating conditions. Definite rules cannot be established on a practical basis for all cases, but the following features should be considered as a working basis for the use of shielding.

Where there is no metallic covering or shield over the insulation, the electric field will be partly in the insulation and partly in whatever lies between the insulation and ground. The external field, if sufficiently intense in air, will generate surface discharge and convert atmospheric oxygen into ozone which may be destructive to rubber insulations and to protective jackets. If the surface of the cable is separated from ground by a thin layer of air and the air gap is subjected to a voltage stress which exceeds the dielectric strength of air, a discharge will occur, causing ozone formation.

The ground may be either a metallic conduit, a damp non-metallic conduit or a metallic binding tape or rings on an aerial cable, a loose metallic sheath, etc. Likewise, damage to non-shielded cable may result when the surface of the cable is moist, or covered with soot, soapy grease or other con-

ducting film and the external field is partly confined by such conducting film so that the charging current is carried by the film to some spot where it can discharge to ground. The resultant intensity of discharge may be sufficient to cause burning of the insulation or jacket.

Where nonshielded nonmetallic jacketed cables are used in underground ducts containing several circuits which must be worked on independently, the external field if sufficiently intense can cause shocks to those who handle or contact energized cable. In cases of this kind, it may be advisable to use shielded cable. Shielding used to reduce hazards of shock should have a resistance low enough to operate protective equipment in case of fault. In some cases, the efficiency of protective equipment may require proper size ground wires as a supplement to shielding. The same considerations apply to exposed installations where cables may be handled by personnel who may not be acquainted with the hazards involved.

Operating voltage limits kV, above which insulation shielding is required

Table 5-1

60 HERTZ POWER CABLE - 100 AND 133% INSULATION LEVEL	
1. Single and multiple conductor cables with metallic sheath or armor	2.4 kV
2. Multiple conductor cables with common overall discharge resisting jacket	2.4 kV
3. Single conductor cables	2.4 kV

Grounding Shielded Cable

When installing shielded cable, metallic shielding must be solidly grounded. Where conductors are individually shielded, each must have its shielding grounded and the shielding of each conductor should be carried across every joint to assure positive continuity of a shielding from one end of the cable to the other. Where grounding conductors are part of the cable assembly, they must be connected with the shielding at both ends of the cable.

For safe and effective operation, the shielding should be grounded at each end of the cable and at each splice. For short lengths or where special bonding arrangements are used, grounding at one point only may be satisfactory.

All grounding connections should be made to the cable shield in such a way as to provide a permanent low resistance bond. Soldering the connection to the cable shield is usually preferable to a mechanical clamp, as there is less danger of a poor connection, loosening, or injury to the cable. The area of contact should be ample to prevent the current from heating the connection and melting the solder.

For additional security, a mechanical device, such as a nut and bolt, may be used to fasten the ends of the connection together. This combination of a soldered and mechanical connection provides permanent low resistance which will maintain contact even though the solder melts.

The wire or strap used to connect the cable shield ground connection to the permanent ground must be of ample size to carry fault currents.

Effect of Grounding Metallic Shield

The metallic coverings of cables must be grounded to provide satisfactory operating and safety conditions. As the method of grounding may affect the current carrying capacity, formulas for calculating losses and correcting the current carrying capacity for those losses may be found on pages 19 and 20.

Installations of shielded single conductor cables must be studied to determine the best method of grounding. This is necessary as voltage is induced in the shield of a single conductor cable carrying alternating current due to the mutual induction between its shield and any other conductors in its vicinity. This induced voltage can result in two conditions:

1. Metal shields bonded or grounded at more than one point have circulating currents flowing in them, the magnitude of which depends on the mutual inductance to the other cables, the current in these conductors, and the resistance of the shield. This circulating current does not depend on the length of the cables nor the number of bonds, providing there are bonds at each end. The only effect of this circulating current is to heat the shield and thereby reduce the effec-

tive current carrying capacity of the cable. If the shield loss exceeds 5 percent or the copper loss, the current carrying capacity should be reduced.

2. Shields bonded or grounded at only one point will have a voltage built up along the shield. The magnitude depends on the mutual inductance to other cables, the current in all the conductors, and the distance to the grounded point. This voltage may cause discharge or create an unsafe condition for workmen. The usual safe potential is about 25 volts for cables having nonmetallic covering over the shield.

Multi-Grounded Shields

If operating conditions permit, it is desirable to bond and ground cable shields at more than one point, to improve the reliability and safety of the circuit. This decreases the reactance to fault currents and increases the human safety factor.

Some general recommendations may be made, but it must be remembered that variations in insulation thickness, conductivity of sheath, spacing of conductors, and the current being carried all affect these recommendations. It is impossible to cover all these variations.

The following single conductor cables carrying alternating currents may, in general, be operated with multisheath grounds.

1. Shielded cables up to and including 250 kcmil with phases in separate ducts.

Cables in ac circuits should not be installed with each phase in separate magnetic conduits under any circumstances due to the high inductance under such conditions. Cables in a-c circuits should not be installed with each phase in separate metallic non-magnetic conduit when their size exceeds 4/0 unless the conduit is insulated to prevent circulating currents.

2. Shielded cables installed with all three phases in the same duct.

3. Cables of any size may be installed with multi-shield grounds, provided allowance is made for heating due to current induced in the shield. Cables carrying direct current may always be solidly grounded at more than one point, except where insulating joints are required to isolate earth currents or to permit cathodic protection.

Shields Grounded at One Point

Shields of single conductor cable carrying alternating current will have a potential buildup if grounded at only one point. Historically, a maximum shield voltage limit has been 25 volts. However, with the introduction of more insulating jackets, utilities have allowed higher voltages to be used. For more information, see ANSI/IEEE Std 575-1988 "Guide for the Application of Sheath-Bonding Methods for Single-conductor Cables and the Calculation of Induced voltages and Currents in Cable Sheaths".

Table 5-2 illustrates an example of the maximum lengths which should be allowed between insulating joints in order to keep the shield potential below the historical maximum safe value of 25 volts for specific cables, installation configurations and current loads.

Maximum lengths for single conductor cables with shields insulated at joints and terminals and grounded at end of each section only.

Table 5-2

Size Conductor	One Phase per duct (ft)	Three Phases per duct (ft)
1/0	1410	5105
4/0	970	3540
350	785	2740
500	665	2325
750	560	1875
1,000	500	1680
2,000	405	—

Based on 15 kV cables operating at full load, 100% load factor and the equations given in Table 5-3 with ampacities given in Table 6-5 for 1/C per duct and ampacities in Table 6-10 for 3 x 1/C cables per duct.

The lengths given in Table 5-2 apply to cables operating at 60 Hz a-c voltage. Many conditions will permit longer lengths between insulating joints, as for example, where cables are operating at less than full load.

The lengths given are from the grounded point to the insulating joint. If the mid-point of the section is grounded, the total length between insulating joints may be twice the length given.

Induced Shield Voltages, Currents and Losses

Table 5-3 gives formulas for calculating the induced voltage and shield loss for single conductor cables. These formulas neglect proximity loss, but are accurate enough for practical purposes.

It is assumed that the cables are carrying balanced currents.

For cables installed three per conduit use arrangement II. The spacing, S, in this case will be equal to the outside diameter of the cable increased by 20 percent to allow for random spacing in the conduit.

Cross-Bonding

Another method to reduce shield currents and voltages is to employ cross bonding of shields at specific locations. There are numerous arrangements such as end-point, mid-point, cross-bonded without transposition, cross-bonded with transposition, sectionalized cross-bonding, etc. Refer to ANSI/IEEE Std 575 for in-depth details.

Formulas for calculating shield voltages — currents and losses for single-conductor cables

Table 5-3

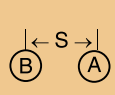
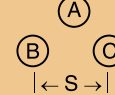
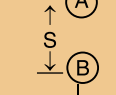
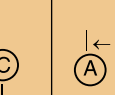
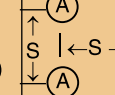
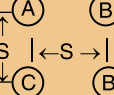
Cable Arrangement Number and Diagram	I One phase	II Equilateral	III Rectangular	IV Flat	V Two circuit	VI Two circuit
						
INDUCED SHIELD VOLTAGE — SHIELDS OPEN CIRCUITED (MULTIPLY BY 10 ⁻⁶ TO OBTAIN VOLTS PER FT.)						
CABLE — A } CABLE — C } CABLE — B	IX_M IX_M	IX_M IX_M	$\frac{I}{2}\sqrt{3Y^2 + (X_M - \frac{A}{2})^2}$ IX_M	$\frac{I}{2}\sqrt{3Y^2 + (X_M - A)^2}$ IX_M	$\frac{I}{2}\sqrt{3Y^2 + (X_M - \frac{B}{2})^2}$ $I(X_M + \frac{A}{2})$	$\frac{I}{2}\sqrt{3Y^2 + (X_M - \frac{B}{2})^2}$ $I(X_M + \frac{A}{2})$
SHIELD LOSS — SHIELDS SOLIDLY BONDED (MULTIPLY BY 10 ⁻⁶ TO OBTAIN WATTS PER FT.)						
CABLE — A } CABLE — C } CABLE — B	$I^2R_S \frac{X_M^2}{R_S^2 + X_M^2}$	$(I^2R_S) \frac{X_M^2}{R_S^2 + X_M^2}$	$I^2R_S \left[\frac{(P^2 + 3Q^2) \pm 2\sqrt{3}(P - Q) + 4}{4(P^2 + 1)(Q^2 + 1)} \right]$			
Total loss	$I^2R_S \frac{X_M^2}{R_S^2 + X_M^2}$ $2I^2R_S \frac{X_M^2}{R_S^2 + X_M^2}$	$(I^2R_S) \frac{X_M^2}{R_S^2 + X_M^2}$ $(3I^2R_S) \frac{X_M^2}{R_S^2 + X_M^2}$	$I^2R_S \left[\frac{1}{Q^2 + 1} \right]$ $3I^2R_S \left[\frac{P^2 + Q^2 + 2}{2(P^2 + 1)(Q^2 + 1)} \right]$			
$P = \frac{R_S}{Y}$ $Q = \frac{R_S}{Z}$	Where:	$Y =$ $Z =$	$X_M + \frac{A}{2}$ $X_M - \frac{A}{6}$	$X_M + A$ $X_M - \frac{A}{3}$	$X_M + A + \frac{B}{2}$ $X_M + \frac{A}{3} - \frac{B}{6}$	$X_M + A - \frac{B}{2}$ $X_M + \frac{A}{3} - \frac{B}{6}$

To facilitate calculating the shield resistance, and reactance, the following formulas may be used:

$$X_m = 2\pi f (0.1404 \log_{10} \frac{S}{r_m}) \text{ micro-ohms per ft.}$$

$$A = 2\pi f (0.1404 \log_{10} 2) \text{ micro-ohms per ft.}$$

$$B = 2\pi f (0.1404 \log_{10} 5) \text{ micro-ohms per ft.}$$

$$R_S = \frac{\rho}{8r_m t} \text{ micro-ohms per ft.}$$

R_S = resistance of shield (micro-ohms per ft.)

t = thickness of metal tapes or sheath used for shielding (inches)

f = frequency (60 Hertz)

S = spacing between center of cables (inches)

r_m = mean radius of shield (inches)

I = conductor current (amperes)

ρ = apparent resistivity of shield in ohms-cir mil/ft. at operating temperature (assumed 50°C).

This includes allowance for spiraling of tapes or wires.

For 60 Hertz

$$X_m = 52.92 \log_{10} \frac{S}{r_m} \text{ micro-ohms per ft.}$$

$$A = 15.93 \text{ micro-ohms per ft.}$$

$$B = 36.99 \text{ micro-ohms per ft.}$$

Effective Values of ρ

- Overlapped Copper Tape 30 ohms-cir mil/ft.
- Overlapped Bronze Tape 90-10 47 ohms-cir mil/ft.
- Overlapped Copper Alloy Tape C19400 . 52 ohms-cir mil/ft.
- Overlapped Cupro-Nickel Tape 80-20 . 350 ohms-cir mil/ft.
- Copper Wires 10.575 ohms-cir mil/ft.
- Lead Sheath 150 ohms-cir mil/ft.
- Smooth Aluminum Sheath 20 ohms-cir mil/ft.
- Corrugated, Welded Bronze Sheath . . . 27 ohms-cir mil/ft.
- Corrugated, Welded Aluminum Sheath . 30 ohms-cir mil/ft.
- Aluminum Interlock Armor 40 ohms-cir mil/ft.
- Galv-Steel Armor Wire 85 ohms-cir mil/ft.
- Galv-Steel Interlock Armor 70 ohms-cir mil/ft.
- Stainless Steel SS304 421 ohms-cir mil/ft.

Example Problems

Permissible Ampacities With Shield Losses

The permissible current carrying capacities of cables may be calculated taking into account the shield loss, thus allowing operation with shields solidly bonded and grounded at more than one point.

An approximate correction factor which is on the conservative side and is close enough for most purposes may be obtained by correcting the current taken from the proper current carrying capacity table by:

$$\text{Correction factor} = \sqrt{\frac{R}{R_a}}$$

$$\text{Where } R_a = \frac{\text{shield loss} + I^2 R}{I^2}$$

I = conductor current (amperes)

R = effective a-c resistance of the conductor including skin and proximity effect (ohms per ft.)

Example of Sheath Voltage, Currents and Losses

Situation: 3-1/C, 1000 kcmil 15kV cables with a 5 mil copper tape shielding .110" jacket in a flat duct arrangement, spacing 7.5 inches. For 3-1/C cables in ducts at 75% L.F., I = 890 amp. Cable OD = 2.180

$$r_m = \frac{(2.180 - .220 - .005)}{2} = .978$$

$$X_m = 52.92 \log \frac{7.5}{.978} = 46.82 \text{ micro-ohms/ft.}$$

$$A = 15.93 \text{ micro ohms/ft.}$$

$$Y = X_m + A = 46.82 + 15.93 = 62.75 \text{ micro-ohms/ft.}$$

$$Z = X_m - \frac{A}{3} = 46.82 - 5.31 = 41.51 \text{ micro-ohms/ft.}$$

$$R_s = \frac{\rho}{8r_{mt}} = \frac{30}{8(.978)(.005)} = 767 \text{ micro-ohms/ft.}$$

$$P = \frac{R_s}{Y} = \frac{767}{62.75} = 12.22 \quad Q = \frac{R_s}{Z} = \frac{767}{41.51} = 18.48$$

The Induced Shield Voltage (V): Cables A or C:

$$V = \frac{I}{2} \sqrt{3Y^2 + (X_m - A)^2} = \frac{I}{2} \sqrt{3(62.75)^2 + (30.89)^2}$$

$$V = I \times 56.5 \text{ micro volts per ft.}$$

$$V = 890 \times 56.5 \times 10^{-6} = .050 \text{ volts pr ft.}$$

$$\text{Maximum ungrnd length} = \frac{25 V}{.050 V / \text{ft.}} = 500 \text{ ft.}$$

Cable B:

$$V = I \times X_m = 890 \times 46.82 \times 10^{-6} = .0417 \text{ volts per ft.}$$

Shield Loss (P):

Cables A or C

$$P_s = I^2 R_s \left[\frac{(P^2 + 3Q^2) \pm 2\sqrt{3}(P - Q) + 4}{4(P^2 + 1)(Q^2 + 1)} \right] \times 10^{-6}$$

$$P_s = I^2 R_s \left[\frac{(12.22)^2 + 3(18.48)^2 \pm 2\sqrt{3}(12.22 - 18.48) + 4}{4[(12.22)^2 + 1][(18.48)^2 + 1]} \right] \times 10^{-6}$$

$$P_s = (890)^2 \times 767 \times .00582 \times 10^{-6} = 3.536 \text{ watts per ft.}$$

Cable B:

$$P_s = I^2 R_s \left[\frac{1}{Q^2 + 1} \right] \frac{(890)^2 767}{(18.48)^2 + 1} \times 10^{-6}$$

$$P_s = 1.77 \text{ watts per ft.}$$

Total Shield Losses:

$$P_s = 3I^2 R_s \left[\frac{P^2 + Q^2 + 2}{2(P^2 + 1)(Q^2 + 1)} \right] \times 10^{-6}$$

$$P_s = 3I^2 R_s \left[\frac{(12.22)^2 + (18.48)^2 + 2}{2(12.22^2 + 1)(18.48^2 + 1)} \right] \times 10^{-6}$$

$$P_s = 3(890)^2 \times 767 \times .00478 \times 10^{-6} = 8.72 \text{ watts per ft.}$$

Calculation of Permissible Ampacity

when Shield Losses are present.

R = Rdc @ 25C x Temp. Corr. x AC/DC Ratio

$$R = 11.1 \times 10^{-6} \times 1.25 \times 1.067$$

$$R@90C = 14.8 \times 10^{-6} \text{ ohms per ft.}$$

$$R_a = \frac{\text{Shield loss} + I^2 R}{I^2} = \frac{3.536 + (890)^2 \times 14.8 \times 10^{-6}}{(890)^2}$$

$$R_a = 19.26 \times 10^{-6} \text{ ohms per ft.}$$

$$\text{Correction Factor } \sqrt{\frac{R}{R_a}} = \sqrt{\frac{14.8 \times 10^{-6}}{19.26 \times 10^{-6}}} = .877$$

$$I = (890) (.877) = 780 \text{ amp}$$

The ampacity tables in this bulletin cover the installation conditions most commonly encountered. The actual current carrying capacities tables are derived from AIEE-IPCEA "Power-Cable Ampacities", joint publication S-135-1 and P-46-426 which includes more complete tables covering additional earth resistivities and load factors. Additional information and updated ampacities can be found in the following reference documents: ICEA P-117-734 Ampacities For Single-Conductor Solid Dielectric Power Cable 15kV Through 35kV and IEEE Std 835 Standard Power Cable Ampacity Tables.

The following tables relate to insulated cables in underground ducts, in free air, in conduit in air, and directly buried in earth. The values are based on 90°C and 105°C conductor temperatures and an ambient temperature of 20°C for all cables in underground duct or directly buried in the ground and 40°C for all cables in air.

Ampacity values are based on a 100% load factor. By definition the load factor is the ratio of the average load over a designated period of time to the peak load occurring in that period. For variable continuous loading the base period is 24 hours. These apply for cables in conventional underground duct installations since there is a time lag between the temperature rise of the cable and the temperature rise of the duct structure and surrounding earth. This heat-time-lag characteristic permits assigning higher current ratings for cables in ducts which do not carry full load continuously. For in-air installations 100% load factor is used. These ratings are used for any load factor due to the relatively low thermal capacity of the surrounding air.

Emergency Overloads

For 5 to 46kV rated cable, operations at the emergency overload temperature rated 130°C for insulations rated 90°C continuous and 140°C for insulations rated 105°C continuous, shall not exceed 1500 hours cumulative during the lifetime of the cable. Operation at any temperature above the maximum rated conductor normal operating temperature shall be included in the 1500 hours.

Lower temperatures for emergency overload conditions may be required because of the type of material used in the

Correction Factors For Various Ambient Air Temperatures

Table 6 - 1

AMBIENT AIR TEMPERATURE						
		30°C	35°C	40°C	45°C	50°C
Conductor Temperature in °C	75	0.97	0.92	0.86	0.79	0.72
	85	1.06	1.01	0.96	0.90	0.84
	90	1.10	1.05	1.00	0.95	0.89
	100	1.17	1.12	1.08	1.03	0.98
	105	1.20	1.16	1.11	1.07	1.03
	110	1.23	1.19	1.15	1.11	1.06
	125	1.31	1.27	1.24	1.20	1.16
	130	1.33	1.30	1.27	1.23	1.19
	140	1.38	1.35	1.32	1.28	1.25

cable, joints and terminations or because of cable environmental conditions. See appropriate ICEA Standard or consult manufacturer.

Temperature Correction Factors

To determine ampacities for ambient temperatures and conductor temperatures other than those indicated on the individual tables, multiply table values by the correction factors shown in Table 6-1 or Table 6-2.

Correction Factors For Various Ambient Earth Temperatures

Table 6 - 2

AMBIENT EARTH TEMPERATURE						
		10°C	15°C	20°C	25°C	30°C
Conductor Temperature in °C	75	0.99	0.95	0.91	0.87	0.82
	85	1.04	1.02	0.97	0.93	0.89
	90	1.07	1.04	1.00	0.96	0.93
	100	1.12	1.09	1.05	1.02	0.98
	105	1.14	1.11	1.08	1.05	1.01
	110	1.16	1.13	1.10	1.07	1.04
	125	1.22	1.19	1.16	1.14	1.11
	130	1.24	1.21	1.18	1.16	1.13
	140	1.27	1.24	1.22	1.19	1.17

Effect of Grouping

Ampacities for cable in air or conduit in air are based on a single isolated cable or conduit. Where the spacing between cable or conduit surfaces is not greater than the cable or conduit diameter, the current rating should be reduced in accordance with values given in the table. Spacings less than one quarter of cable or conduit diameter are not covered.

Group Correction Factors

Table 6 - 3

NUMBER OF CABLES IN AIR						
Horizontally	1	2	3	4	5	6
Vertically						
1	1.00	0.93	0.87	0.84	0.83	0.82
2	0.89	0.83	0.79	0.76	0.75	0.74
3	0.80	0.76	0.72	0.70	0.69	0.68

Group Correction Factors

Table 6 - 4

NUMBER OF CONDUITS IN AIR						
Horizontally	1	2	3	4	5	6
Vertically						
1	1.00	0.94	0.91	0.88	0.87	0.86
2	0.92	0.87	0.84	0.81	0.80	0.79
3	0.85	0.81	0.78	0.76	0.75	0.74

Ampacity Tablets

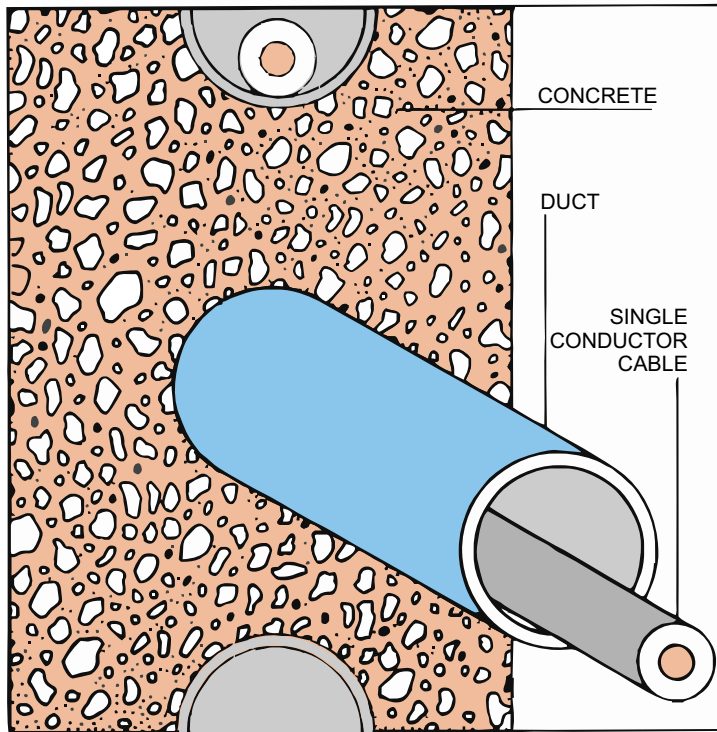

Single conductor cable underground ducts

Open circuited shield operation, i.e. shields bonded and grounded at one point only.

One cable per non-metallic duct, all cables equally loaded and in outside ducts only.

Earth ambient temperature 20°C

Earth thermal resistivity RHO 90

100% Load Factor

Depth of burial - 30" to top of duct bank with ducts on 7 1/2" centers.

One circuit — three cables in separate ducts

Table 6-5

One conductor, **Copper** — underground ducts

One conductor, **Aluminum** — underground ducts

Conductor Size AWG-kcmil	Non-Shielded	Shielded				Non-Shielded	Shielded			
	600-2000 Volts Ampacity	2001-5000 Volts Ampacity		5001-35000 Volts Ampacity		600-2000 Volts Ampacity	2001-5000 Volts Ampacity		5001-35000 Volts Ampacity	
	90° C (194°F)	90° C (194°F)	105°C (221°F)	90° C (194°F)	105°C (221°F)	90° C (194°F)	90° C (194°F)	105°C (221°F)	90° C (194°F)	105°C (221°F)
8	80	80	86	—	—	62	62	67	—	—
6	104	106	114	106	114	81	83	89	83	89
4	135	137	148	137	148	105	107	115	107	115
2	176	178	192	179	193	137	139	150	139	150
1	202	204	220	204	220	157	159	171	159	171
1/0	231	233	251	232	250	180	181	195	181	195
2/0	264	265	286	265	286	205	206	222	206	222
3/0	301	302	326	302	326	235	236	254	235	253
4/0	345	345	372	344	371	269	269	290	268	289
250	379	379	409	378	407	296	296	319	295	318
350	461	460	496	457	493	360	359	387	357	385
500	564	561	605	557	600	442	440	474	436	470
750	706	702	757	695	749	556	553	596	547	590
1000	823	816	880	807	870	653	648	699	641	691
1250	920	913	984	902	972	738	732	789	723	779
1500	1004	995	1073	981	1058	813	806	869	795	857
1750	1077	1066	1149	1051	1133	880	872	940	859	926
2000	1139	1125	1213	1109	1196	940	930	1003	917	989

Ampacity Tablets

Two circuits — six cables in separate ducts

Table 6-6

One conductor, **Copper** — underground ducts

One conductor, **Aluminum**— underground ducts

Conductor Size AWG-kcmil	Non-Shielded	Shielded				Non-Shielded	Shielded			
	600-2000 Volts Ampacity	2001-5000 Volts Ampacity		5001-35000 Volts Ampacity		600-2000 Volts Ampacity	2001-5000 Volts Ampacity		5001-35000 Volts Ampacity	
	90° C (194°F)	90° C (194°F)	105°C (221°F)	90° C (194°F)	105°C (221°F)	90° C (194°F)	90° C (194°F)	105°C (221°F)	90° C (194°F)	105°C (221°F)
8	71	71	77	—	—	56	56	60	—	—
6	93	94	101	94	101	72	73	79	73	79
4	120	121	130	121	130	93	94	101	94	101
2	155	156	168	156	168	121	121	130	121	130
1	176	177	191	177	191	138	138	149	138	149
1/0	201	202	218	201	217	157	157	169	157	169
2/0	226	229	247	228	246	178	178	192	178	192
3/0	260	260	280	259	279	203	203	219	202	218
4/0	296	296	319	294	317	231	231	249	230	248
250	325	324	349	322	347	253	253	273	251	271
350	391	390	420	387	417	306	304	328	302	326
500	475	472	509	468	505	372	370	399	367	396
750	589	585	631	579	624	464	461	497	456	492
1000	682	676	729	668	720	541	537	579	530	571
1250	759	752	811	742	800	608	603	650	595	641
1500	824	816	880	804	867	667	661	713	651	702
1750	880	871	939	858	925	719	712	768	702	757
2000	928	916	987	902	972	766	757	816	746	804

Three circuits — nine cables in separate ducts

Table 6-7

One conductor, **Copper** — underground ducts

One conductor, **Aluminum**— underground ducts

Conductor Size AWG-kcmil	Non-Shielded	Shielded				Non-Shielded	Shielded			
	600-2000 Volts Ampacity	2001-5000 Volts Ampacity		5001-35000 Volts Ampacity		600-2000 Volts Ampacity	2001-5000 Volts Ampacity		5001-35000 Volts Ampacity	
	90° C (194°F)	90° C (194°F)	105°C (221°F)	90° C (194°F)	105°C (221°F)	90° C (194°F)	90° C (194°F)	105°C (221°F)	90° C (194°F)	105°C (221°F)
8	68	68	73	—	—	53	53	57	—	—
6	87	88	95	88	95	68	69	74	69	74
4	112	114	123	114	123	88	88	95	88	95
2	145	146	157	146	157	113	114	123	113	122
1	165	166	179	165	178	129	129	139	129	139
1/0	188	188	203	188	203	146	147	158	146	157
2/0	213	213	230	212	229	166	166	179	165	178
3/0	242	242	261	241	260	188	188	203	188	203
4/0	275	274	295	273	294	214	214	231	213	230
250	301	300	323	298	321	235	234	252	233	251
350	362	360	388	357	385	282	281	303	279	301
500	438	435	469	431	465	343	341	368	337	363
750	541	537	579	531	572	426	423	456	418	451
1000	625	619	667	611	659	496	492	530	485	523
1250	694	687	741	678	731	556	551	594	544	586
1500	752	744	802	733	790	609	603	650	594	640
1750	803	794	856	781	842	656	649	700	639	689
2000	845	834	899	821	885	698	689	743	678	731

Ampacity Tablets

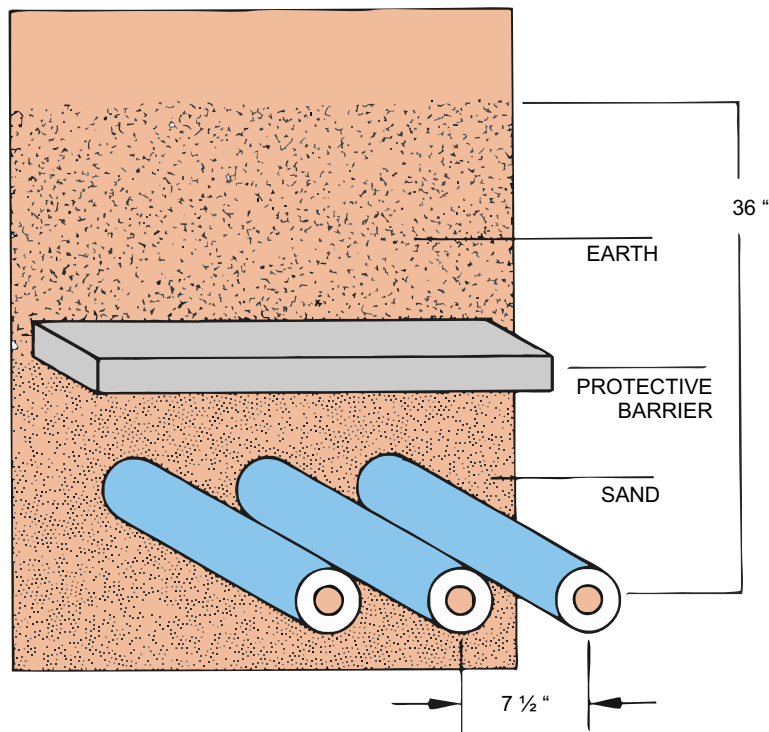

Single conductor cable direct burial

1/C group buried 36" deep with cables laid on 7-1/2" centers, open circuited shield operation, i.e. shields bonded and grounded at one point only.

Earth ambient temperature 20°C
Earth thermal resistivity RHO 90
100% load factor

One circuit — three cables

Table 6-8

One conductor, **Copper** — direct burial

One conductor, **Aluminum** — direct burial

Conductor Size AWG-kcmil	Non-Shielded		Shielded			Non-Shielded		Shielded		
	600-2000 Volts Ampacity		2001-5000 Volts Ampacity		5001-35000 Volts Ampacity	600-2000 Volts Ampacity		2001-5000 Volts Ampacity		5001-35000 Volts Ampacity
	90° C (194°F)	90° C (194°F)	90° C (194°F)	105°C (221°F)	90° C (194°F)	105°C (221°F)	90° C (194°F)	90° C (194°F)	105°C (221°F)	90° C (194°F)
8	108	110	115	—	—	84	85	90	—	—
6	139	140	150	130	140	108	110	115	110	110
4	180	180	195	170	180	140	140	150	130	140
2	231	230	250	210	225	180	180	195	165	175
1	261	260	280	240	260	203	205	220	185	200
1/0	297	295	320	275	295	231	230	250	215	230
2/0	337	335	365	310	335	263	265	285	245	260
3/0	384	385	415	355	380	299	300	320	275	295
4/0	434	435	465	405	435	338	340	365	315	340
250	472	470	510	440	475	368	370	395	345	370
350	569	570	615	535	575	444	445	480	415	450
500	690	690	745	650	700	540	540	580	510	545
750	847	845	910	805	865	667	665	720	635	680
1000	980	980	1055	930	1005	778	780	840	740	795
1250	1083	1085	1165	1035	1115	868	870	935	830	895
1500	1176	1175	1265	1125	1210	952	950	1025	910	980
1750	1257	1255	1355	1200	1295	1027	1025	1105	980	1060
2000	1325	1325	1430	1265	1365	1094	1095	1180	1045	1130

Ampacity Tablets

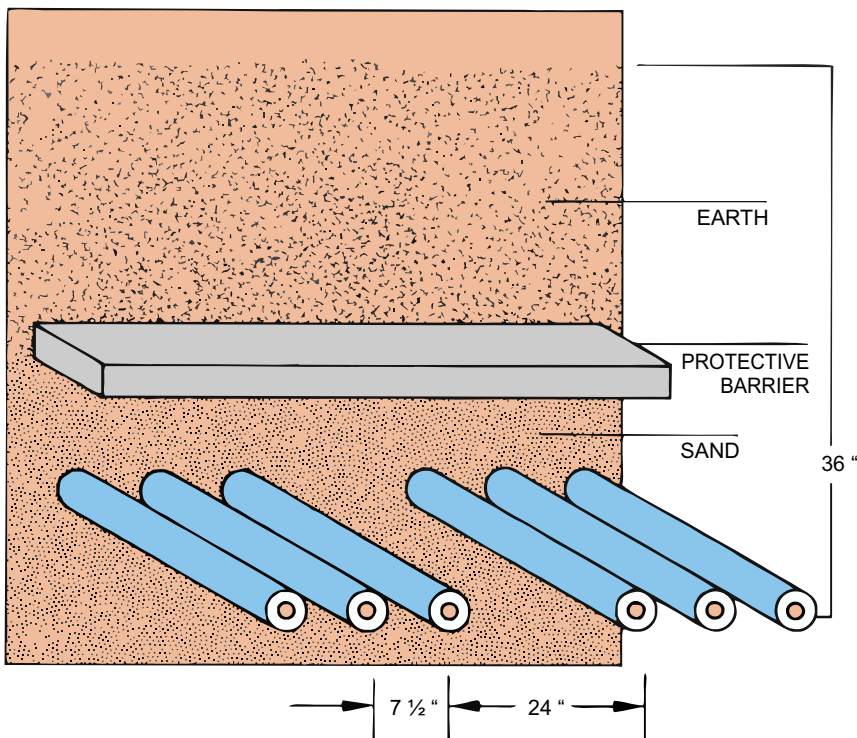

Single conductor cable direct burial

1/C groups buried 36" deep with cables laid on 7-1/2" centers, second circuit similarly spaced. Groups separated 24", open circuited shield operation, i.e. shields bonded and grounded at one point only.

Earth ambient temperature 20°C
 Earth thermal resistivity RHO 90
 100% load factor

Two circuits — six cables

Table 6-9

One conductor, **Copper** — direct burial

One conductor, **Aluminum** — direct burial

Conductor Size AWG-kcmil	Non-Shielded	Shielded				Non-Shielded	Shielded			
	600-2000 Volts Ampacity	2001-5000 Volts Ampacity		5001-35000 Volts Ampacity		600-2000 Volts Ampacity	2001-5000 Volts Ampacity		5001-35000 Volts Ampacity	
	90° C (194°F)	90° C (194°F)	105°C (221°F)	90° C (194°F)	105°C (221°F)	90° C (194°F)	90° C (194°F)	105°C (221°F)	90° C (194°F)	105°C (221°F)
8	101	100	110	—	—	79	80	85	—	—
6	130	130	140	120	130	101	100	110	95	100
4	167	165	180	160	170	130	130	140	125	130
2	214	215	230	195	210	167	165	180	155	165
1	241	240	260	225	240	188	190	200	175	190
1/0	275	275	295	255	275	214	215	230	200	215
2/0	311	310	335	290	315	243	245	260	225	245
3/0	354	355	380	330	355	276	275	295	255	275
4/0	399	400	430	375	405	311	310	335	290	315
250	435	435	470	410	440	339	340	365	320	345
350	522	520	560	495	530	408	410	440	385	415
500	631	630	680	600	645	494	495	530	470	505
750	773	775	835	740	795	609	610	655	580	625
1000	892	890	960	855	920	708	710	765	680	730
1250	985	985	1060	945	1020	790	790	851	760	820
1500	1068	1070	1150	1025	1105	865	865	930	830	895
1750	1140	1140	1230	1095	1180	932	930	1005	895	965
2000	1200	1200	1295	1150	1240	991	990	1070	950	1025

Ampacity Tablets

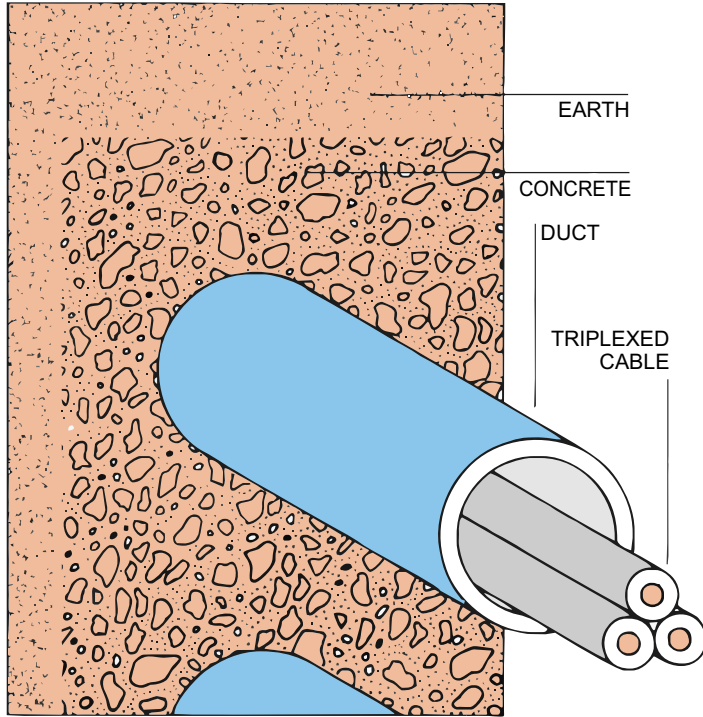

Three single or triplexed cable underground ducts

Closed shield operation. Shields bonded and grounded at multiple points. One triplexed cable or three single conductor cables in a duct. All cables equally loaded and in outside ducts only.

Earth ambient temperature 20°C
 Earth thermal resistivity RHO 90
 100% load factor
 Depth of burial - 30" to top of duct bank with ducts on 7 1/2" centers.

One circuit — three single or triplexed conductors per duct

Table 6-10

Three single or triplexed conductors
Copper — underground ducts

Three single or triplexed conductors
Aluminum — underground ducts

Conductor Size AWG-kcmil	Non-Shielded	Shielded				Non-Shielded	Shielded			
	600-2000 Volts Ampacity	2001-5000 Volts Ampacity		5001-35000 Volts Ampacity		600-2000 Volts Ampacity	2001-5000 Volts Ampacity		5001-35000 Volts Ampacity	
	90° C (194°F)	90° C (194°F)	105°C (221°F)	90° C (194°F)	105°C (221°F)	90° C (194°F)	90° C (194°F)	105°C (221°F)	90° C (194°F)	105°C (221°F)
8	64	64	69	—	—	50	50	54	—	—
6	85	85	92	90	97	66	66	71	70	75
4	111	110	120	115	125	86	86	93	91	98
2	146	145	155	155	165	114	115	125	120	130
1	168	170	180	175	185	131	130	140	135	145
1/0	193	195	210	200	215	150	150	160	155	165
2/0	220	220	235	230	245	172	170	185	175	190
3/0	252	250	270	260	275	196	195	210	200	215
4/0	290	290	310	295	315	226	225	245	230	245
250	319	320	345	325	345	250	250	270	250	270
350	387	385	415	390	415	304	305	325	305	330
500	471	470	505	465	500	372	370	400	370	400
750	585	585	630	565	610	468	470	505	455	490
1000	670	670	720	640	690	546	545	590	525	565

Ampacity Tablets

Three circuits — three single or triplexed conductors per duct

Table 6-11

Three single or triplexed conductors
Copper — underground ducts

Three single or triplexed conductors
Aluminum — underground ducts

Conductor Size AWG-kcmil	Non-Shielded	Shielded				Non-Shielded	Shielded			
	600-2000 Volts Ampacity	2001-5000 Volts Ampacity		5001-35000 Volts Ampacity		600-2000 Volts Ampacity	2001-5000 Volts Ampacity		5001-35000 Volts Ampacity	
	90° C (194°F)	90° C (194°F)	105°C (221°F)	90° C (194°F)	105°C (221°F)	90° C (194°F)	90° C (194°F)	105°C (221°F)	90° C (194°F)	105°C (221°F)
8	56	56	60	—	—	44	44	47	—	—
6	73	73	79	77	83	57	57	61	60	65
4	95	95	100	99	105	74	74	80	77	83
2	123	125	130	130	135	96	96	105	100	105
1	141	140	150	145	155	110	110	120	110	120
1/0	161	160	175	165	175	126	125	135	125	140
2/0	183	185	195	185	200	143	145	155	145	155
3/0	208	210	225	210	225	162	160	175	165	175
4/0	237	235	255	240	255	185	185	200	185	200
250	260	260	280	260	280	203	205	220	200	220
350	313	315	335	310	330	245	245	265	245	260
500	376	375	405	370	395	297	295	320	290	315
750	461	460	495	440	475	369	370	395	355	385
1000	523	525	565	495	535	426	425	460	405	440

Six circuits — three single or triplexed conductors per duct

Table 6-12

Three single or triplexed conductors
Copper — underground ducts

Three single or triplexed conductors
Aluminum — underground ducts

Conductor Size AWG-kcmil	Non-Shielded	Shielded				Non-Shielded	Shielded			
	600-2000 Volts Ampacity	2001-5000 Volts Ampacity		5001-35000 Volts Ampacity		600-2000 Volts Ampacity	2001-5000 Volts Ampacity		5001-35000 Volts Ampacity	
	90° C (194°F)	90° C (194°F)	105°C (221°F)	90° C (194°F)	105°C (221°F)	90° C (194°F)	90° C (194°F)	105°C (221°F)	90° C (194°F)	105°C (221°F)
8	48	48	52	—	—	38	38	41	—	—
6	62	62	67	64	68	48	48	52	50	54
4	80	80	86	82	88	62	62	67	64	69
2	103	105	110	105	115	80	80	86	80	88
1	117	115	125	120	125	91	91	98	90	99
1/0	133	135	145	135	145	104	105	110	105	110
2/0	150	150	160	150	165	117	115	125	115	125
3/0	170	170	185	170	185	133	135	145	130	145
4/0	193	195	210	190	205	151	150	165	150	160
250	211	210	225	210	225	165	165	180	165	175
350	252	250	270	245	265	197	195	210	195	210
500	301	300	325	290	310	238	240	255	230	250
750	365	365	395	350	375	292	290	315	280	305
1000	412	410	445	390	415	336	335	360	320	345

Ampacity Tablets

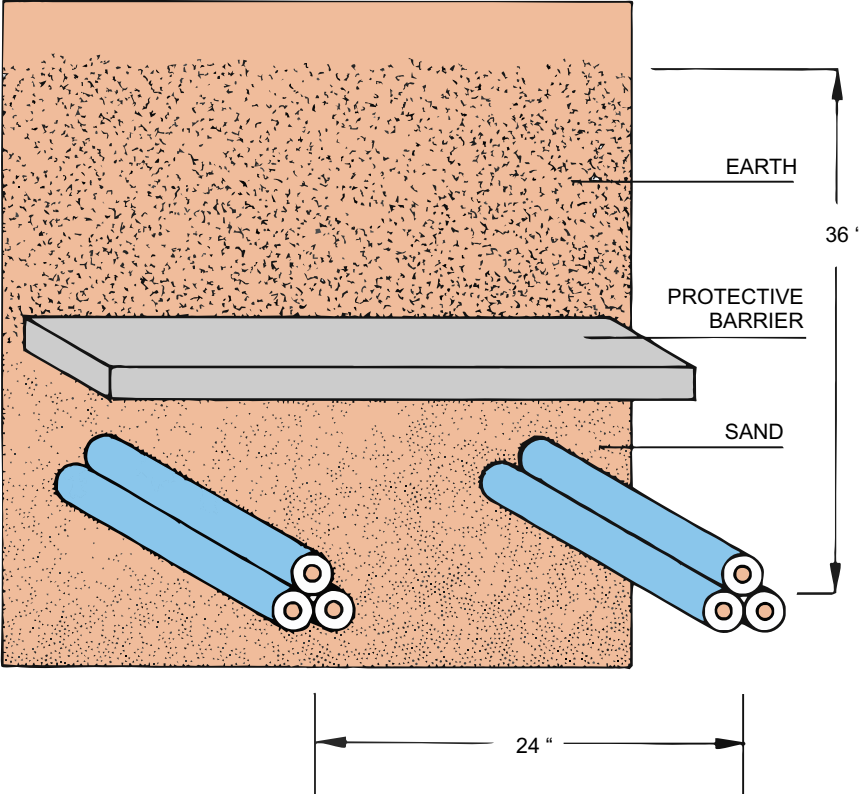

Triplexed cable direct burial

Triplexed cables or three single conductors buried 36" deep and separated by 24". Shields bonded and grounded at multiple points.

- Earth ambient temperature 20°C
- Earth thermal resistivity RHO 90
- 100% load factor

Ampacity Tablets

One circuit

Table 6-13

Three single or triplexed conductors
Copper — direct burial

Three single or triplexed conductors
Aluminum — direct burial

Conductor Size AWG-kcmil	Non-Shielded	Shielded				Non-Shielded	Shielded			
	600-2000 Volts Ampacity	2001-5000 Volts Ampacity		5001-35000 Volts Ampacity		600-2000 Volts Ampacity	2001-5000 Volts Ampacity		5001-35000 Volts Ampacity	
	90° C (194°F)	90° C (194°F)	105°C (221°F)	90° C (194°F)	105°C (221°F)	90° C (194°F)	90° C (194°F)	105°C (221°F)	90° C (194°F)	105°C (221°F)
8	92	90	100	—	—	72	70	80	—	—
6	118	120	125	115	125	92	90	100	90	100
4	153	150	165	150	160	119	120	130	115	125
2	197	195	210	190	200	153	155	165	145	160
1	223	225	240	215	230	174	175	185	165	180
1/0	255	255	275	245	265	198	200	215	190	205
2/0	289	290	310	275	300	226	225	245	215	235
3/0	329	330	355	315	340	257	255	275	245	265
4/0	373	375	400	360	385	291	290	315	280	300
250	408	410	440	390	420	319	320	345	305	330
350	490	490	530	470	505	385	385	415	370	400
500	592	590	640	565	605	467	465	505	445	480
750	724	725	780	685	735	579	580	625	550	595
1000	825	825	890	770	830	672	670	725	635	685

Two circuits

Table 6-14

Three single or triplexed conductors
Copper — direct burial

Three single or triplexed conductors
Aluminum — direct burial

Conductor Size AWG-kcmil	Non-Shielded	Shielded				Non-Shielded	Shielded			
	600-2000 Volts Ampacity	2001-5000 Volts Ampacity		5001-35000 Volts Ampacity		600-2000 Volts Ampacity	2001-5000 Volts Ampacity		5001-35000 Volts Ampacity	
	90° C (194°F)	90° C (194°F)	105°C (221°F)	90° C (194°F)	105°C (221°F)	90° C (194°F)	90° C (194°F)	105°C (221°F)	90° C (194°F)	105°C (221°F)
8	85	85	90	—	—	67	65	70	—	—
6	109	110	115	105	115	85	85	90	85	90
4	141	140	150	140	150	110	110	120	105	115
2	181	180	195	175	185	141	140	150	135	145
1	205	205	220	200	215	160	160	170	155	165
1/0	233	235	250	225	240	182	180	195	175	190
2/0	264	265	285	255	275	206	205	220	200	215
3/0	300	300	325	290	310	234	235	250	225	240
4/0	339	340	365	325	350	265	265	285	255	275
250	370	370	400	355	385	289	290	310	280	300
350	444	445	480	425	460	348	350	375	335	360
500	534	535	575	510	550	421	420	455	405	435
750	649	650	700	615	660	520	520	560	485	535
1000	738	740	795	690	740	601	600	645	565	610

Ampacity Tablets

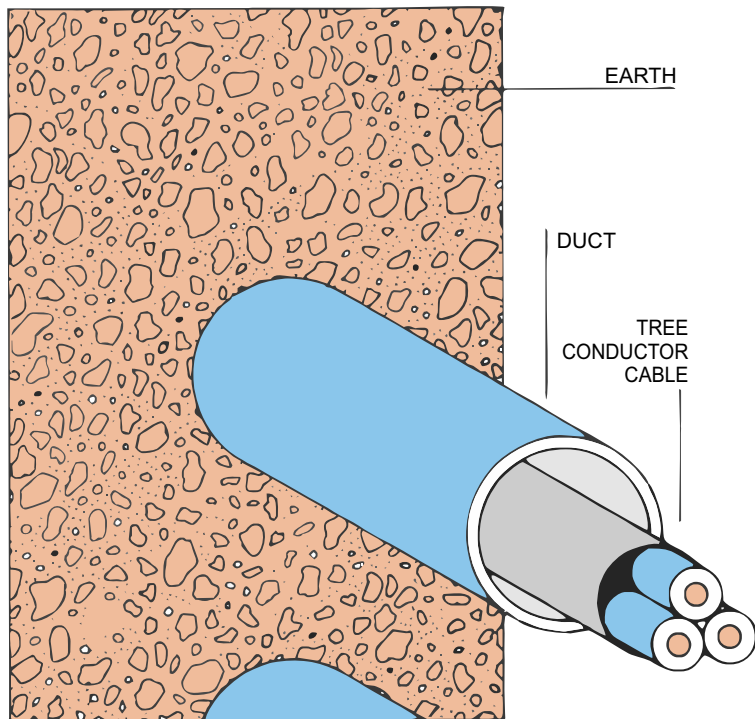

Three conductor cable underground ducts

One cable per duct, all cables equally loaded and in outside ducts only.

Earth ambient temperature 20°C
Earth thermal resistivity RHO 90.
100% load factor

Depth of burial - 30" to top of duct bank
with duct on 7 1/2 centers.

One circuit — one cable in duct bank

Table 6-15

Three conductor
Copper — underground ducts

Three conductor
Aluminum — underground ducts

Conductor Size AWG-kcmil	Non-Shielded	Shielded				Non-Shielded	Shielded			
	600-2000 Volts Ampacity	2001-5000 Volts Ampacity		5001-35000 Volts Ampacity		600-2000 Volts Ampacity	2001-5000 Volts Ampacity		5001-35000 Volts Ampacity	
	90° C (194°F)	90° C (194°F)	105°C (221°F)	90° C (194°F)	105°C (221°F)	90° C (194°F)	90° C (194°F)	105°C (221°F)	90° C (194°F)	105°C (221°F)
8	59	59	64	—	—	46	46	50	—	—
6	78	78	84	88	95	61	61	66	69	74
4	102	100	110	115	125	80	80	86	89	96
2	133	135	145	150	160	104	105	110	115	125
1	154	155	165	170	185	120	120	130	135	145
1/0	177	175	190	195	210	138	140	150	150	165
2/0	202	200	220	220	235	158	160	170	170	185
3/0	231	230	250	250	270	180	180	195	195	210
4/0	264	265	285	285	305	206	205	220	220	240
250	292	290	315	310	335	228	230	245	245	265
350	354	355	380	375	400	278	280	310	295	315
500	429	430	460	450	485	340	340	365	355	385
750	529	530	570	545	585	426	425	460	440	475
1000	599	600	645	615	660	495	495	535	510	545

Ampacity Tablets

Three circuits — three cables in duct bank

Table 6-16

Three conductor
Copper — underground ducts

Three conductor
Aluminum — underground ducts

Conductor Size AWG-kcmil	Non-Shielded	Shielded				Non-Shielded	Shielded			
	600-2000 Volts Ampacity	2001-5000 Volts Ampacity		5001-35000 Volts Ampacity		600-2000 Volts Ampacity	2001-5000 Volts Ampacity		5001-35000 Volts Ampacity	
	90° C (194°F)	90° C (194°F)	105°C (221°F)	90° C (194°F)	105°C (221°F)	90° C (194°F)	90° C (194°F)	105°C (221°F)	90° C (194°F)	105°C (221°F)
8	53	53	57	—	—	41	41	44	—	—
6	69	69	74	75	81	54	54	58	59	64
4	89	89	96	97	105	70	70	75	75	81
2	116	115	125	125	135	90	90	97	100	105
1	133	135	145	140	155	103	105	110	110	120
1/0	151	150	165	160	175	118	120	125	125	135
2/0	172	170	185	185	195	135	135	145	140	155
3/0	196	195	210	205	220	153	155	165	160	175
4/0	223	225	240	230	250	174	175	185	180	195
250	245	245	265	255	270	191	190	205	200	215
350	294	295	315	305	325	231	230	250	240	255
500	354	355	380	360	385	280	280	300	285	305
750	430	430	465	430	465	347	345	375	350	375
1000	484	485	520	485	515	399	400	430	400	430

Six circuits — six cables in duct bank

Table 6-17

Three conductor
Copper — underground ducts

Three conductor
Aluminum — underground ducts

Conductor Size AWG-kcmil	Non-Shielded	Shielded				Non-Shielded	Shielded			
	600-2000 Volts Ampacity	2001-5000 Volts Ampacity		5001-35000 Volts Ampacity		600-2000 Volts Ampacity	2001-5000 Volts Ampacity		5001-35000 Volts Ampacity	
	90° C (194°F)	90° C (194°F)	105°C (221°F)	90° C (194°F)	105°C (221°F)	90° C (194°F)	90° C (194°F)	105°C (221°F)	90° C (194°F)	105°C (221°F)
8	46	46	50	—	—	36	36	39	—	—
6	70	60	65	63	68	46	46	50	49	53
4	77	77	83	81	87	60	60	65	63	68
2	98	98	105	105	110	77	77	83	80	86
1	112	110	120	115	125	87	87	94	90	98
1/0	127	125	135	130	145	99	99	105	105	110
2/0	144	145	155	150	160	112	110	120	115	125
3/0	163	165	175	170	180	128	130	140	130	140
4/0	185	185	200	190	200	144	145	155	150	160
250	202	200	220	205	220	158	160	170	160	170
350	242	240	270	245	275	190	190	205	190	205
500	289	290	310	290	305	228	230	245	230	245
750	348	350	375	340	365	281	280	305	275	295
1000	390	390	420	380	405	322	320	345	315	335

Ampacity Tablets

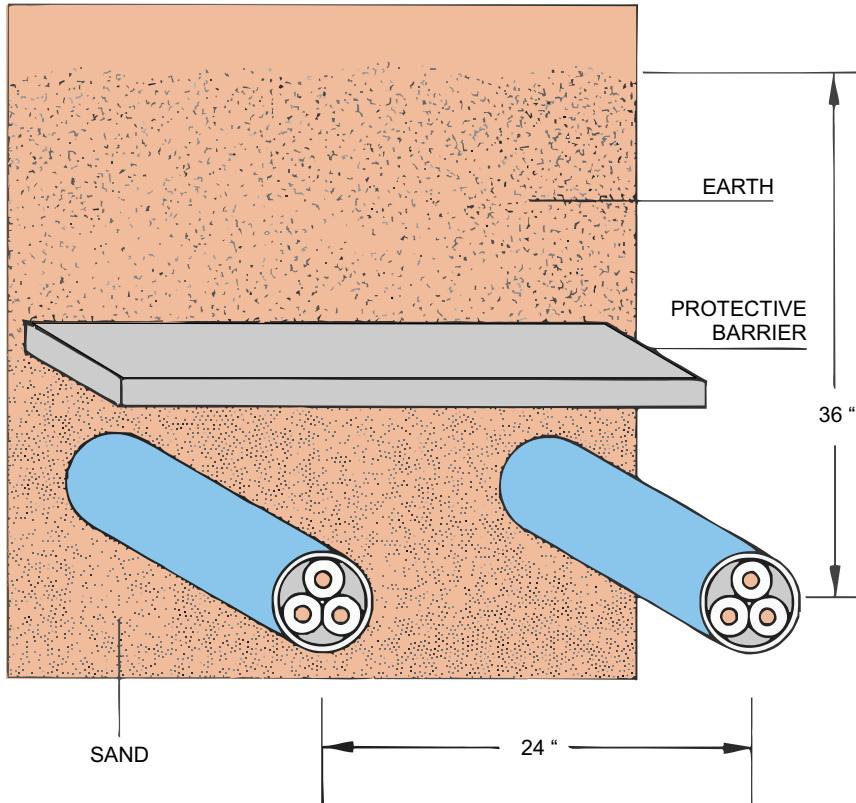

Three Conductor cable direct burial

Cables buried 36" deep. For two cables, currents based on cables being laid on 24" centers.

Earth ambient temperature 20°C
Earth thermal resistivity RHO 90.
100% load factor

Ampacity Tablets

One circuit — one cable

Table 6-18

Three conductor
Copper — direct burial

Three conductor
Aluminum — direct burial

Conductor Size AWG-kcmil	Non-Shielded	Shielded				Non-Shielded	Shielded			
	600-2000 Volts Ampacity	2001-5000 Volts Ampacity		5001-35000 Volts Ampacity		600-2000 Volts Ampacity	2001-5000 Volts Ampacity		5001-35000 Volts Ampacity	
	90° C (194°F)	90° C (194°F)	105°C (221°F)	90° C (194°F)	105°C (221°F)	90° C (194°F)	90° C (194°F)	105°C (221°F)	90° C (194°F)	105°C (221°F)
8	83	85	89	—	—	65	65	70	—	—
6	106	105	115	115	120	82	80	88	90	95
4	137	135	150	145	155	107	105	115	115	125
2	178	180	190	185	200	138	140	150	145	155
1	201	200	215	210	225	156	155	170	165	175
1/0	229	230	245	240	255	178	180	190	185	200
2/0	260	260	280	270	290	203	205	220	210	225
3/0	297	295	320	305	330	231	230	250	240	260
4/0	335	335	360	350	375	262	260	280	270	295
250	367	365	395	380	410	287	285	310	300	320
350	442	440	475	460	495	347	345	375	360	390
500	531	530	570	550	590	420	420	450	435	470
750	648	650	700	665	720	522	520	560	540	580
1000	729	730	785	750	810	602	600	650	620	665

Two circuits — two cables

Table 6-19

Three conductor
Copper — direct burial

Three conductor
Aluminum — direct burial

Conductor Size AWG-kcmil	Non-Shielded	Shielded				Non-Shielded	Shielded			
	600-2000 Volts Ampacity	2001-5000 Volts Ampacity		5001-35000 Volts Ampacity		600-2000 Volts Ampacity	2001-5000 Volts Ampacity		5001-35000 Volts Ampacity	
	90° C (194°F)	90° C (194°F)	105°C (221°F)	90° C (194°F)	105°C (221°F)	90° C (194°F)	90° C (194°F)	105°C (221°F)	90° C (194°F)	105°C (221°F)
8	78	80	84	—	—	61	60	66	—	—
6	99	100	105	105	115	77	75	83	80	88
4	129	130	140	135	145	100	100	110	105	115
2	166	165	180	170	185	129	130	140	135	145
1	187	185	200	195	210	146	145	155	150	165
1/0	213	215	230	220	235	166	165	180	170	185
2/0	242	240	260	250	270	189	190	205	195	210
3/0	275	275	295	280	305	215	215	230	220	240
4/0	311	310	335	320	345	243	245	260	250	270
250	340	340	365	350	375	266	265	285	275	295
350	408	410	440	420	450	320	320	345	330	355
500	488	490	525	500	535	386	385	415	395	425
750	593	595	640	605	650	478	480	515	485	525
1000	666	665	715	675	730	550	550	590	560	600

Ampacity Tablets

Single conductor cable in air

Open circuited shield operation, i.e. shields bonded and grounded at one point only.

Any load factor from 30 to 100%. The ampacities are for a single, loaded cable in still air. In a group of loaded cables in close proximity in air, exposed or enclosed, follow the correction method shown on page 21.

Air ambient temperature is 40°C.

One cable per support or messenger

Copper

Table 6-20

Conductor Size AWG- kcmil	Non-Shielded	Shielded					
	600-5000 Volts Ampacity	2001-5000 Volts Ampacity		5001-15,000 Volts Ampacity		15,001-35,000 Volts Ampacity	
	90° C (194°F)	90° C (194°F)	105°C (221°F)	90° C (194°F)	105°C (221°F)	90° C (194°F)	105°C (221°F)
8	83	83	93	—	—	—	—
6	109	110	120	110	125	—	—
4	145	145	160	150	165	—	—
2	192	190	215	195	215	—	—
1	223	225	250	225	250	225	250
1/0	258	260	290	260	290	260	290
2/0	298	300	330	300	335	300	330
3/0	345	345	385	345	385	345	380
4/0	400	400	445	400	445	395	445
250	445	445	495	445	495	440	490
350	552	550	615	550	610	545	605
500	695	695	775	685	765	680	755
750	898	900	1000	885	990	870	970
1000	1076	1075	1200	1060	1185	1040	1160
1250	1228	1230	1370	1210	1350	1185	1320
1500	1367	1365	1525	1345	1500	1315	1465
1750	1493	1495	1665	1470	1640	1430	1595
2000	1606	1605	1790	1575	1755	1535	1710

Aluminum

Conductor Size AWG- kcmil	Non-Shielded	Shielded					
	600-5000 Volts Ampacity	2001-5000 Volts Ampacity		5001-15,000 Volts Ampacity		15,001-35,000 Volts Ampacity	
	90° C (194°F)	90° C (194°F)	105°C (221°F)	90° C (194°F)	105°C (221°F)	90° C (194°F)	105°C (221°F)
8	64	64	71	—	—	—	—
6	85	85	95	87	97	—	—
4	113	115	125	115	130	—	—
2	150	150	165	150	170	—	—
1	174	175	195	175	195	175	195
1/0	201	200	225	200	225	200	225
2/0	232	230	260	235	260	230	260
3/0	269	270	300	270	300	270	300
4/0	312	310	350	310	350	310	345
250	347	345	385	345	385	345	380
350	431	430	480	430	480	430	475
500	544	545	605	535	600	530	590
750	707	710	790	700	780	685	765
1000	853	855	950	840	940	825	920
1250	982	980	1095	970	1080	950	1055
1500	1103	1105	1230	1085	1215	1060	1180
1750	1216	1215	1355	1195	1335	1165	1300
2000	1321	1320	1475	1295	1445	1265	1410

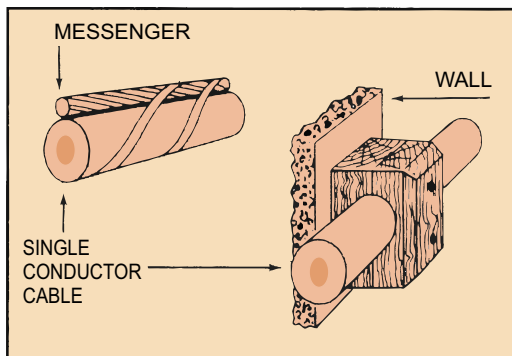

Ampacity Tablets

Three single or triplexed conductors — in air

Closed shield operation. Shields bonded and grounded at multiple points. Any load factor from 30 to 100%.

Also applies to single conductors in a group and in contact with each other.

The ampacities are for a single, loaded cable in still air. In a group of loaded cables in close proximity in air, exposed or enclosed, follow the correction method shown on page 21.

For ambient temperatures other than indicated, use correction factors shown on page 21.

Air ambient temperature 40°C.

Three cables per support or messenger

Copper

Table 6-21

Conductor Size AWG- kcmil	Non-Shielded	Shielded			
	600-5000 Volts Ampacity	2001-5000 Volts Ampacity		5001-35,000 Volts Ampacity	
	90° C (194°F)	90° C (194°F)	105°C (221°F)	90° C (194°F)	105°C (221°F)
8	66	65	74	—	—
6	89	90	99	100	110
4	117	120	130	130	140
2	158	160	175	170	195
1	185	185	205	195	225
1/0	214	215	240	225	255
2/0	247	250	275	260	295
3/0	287	290	320	300	340
4/0	335	335	375	345	390
250	374	375	415	380	430
350	464	465	515	470	525
500	580	580	645	580	650
750	747	750	835	730	820
1000	879	880	980	850	950

Aluminum

Conductor Size AWG- kcmil	Non-Shielded	Shielded			
	600-5000 Volts Ampacity	2001-5000 Volts Ampacity		5001-35,000 Volts Ampacity	
	90° C (194°F)	90° C (194°F)	105°C (221°F)	90° C (194°F)	105°C (221°F)
8	51	50	57	—	—
6	69	70	77	75	84
4	91	90	100	100	110
2	123	125	135	130	150
1	144	145	160	150	175
1/0	167	170	185	175	200
2/0	193	195	215	200	230
3/0	224	225	250	230	265
4/0	262	265	290	270	305
250	292	295	325	300	335
350	364	365	405	370	415
500	458	460	510	460	515
750	598	600	665	590	660
1000	716	715	800	700	780

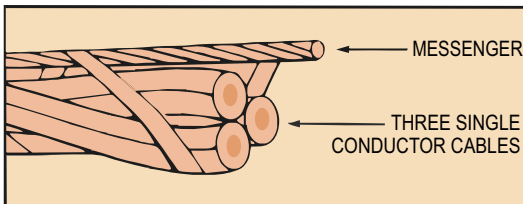

Cable in Tray

For single and multi-conductor cables installed in cable tray, refer to NEC Code ampacity tables. For non-NEC applications, refer to ICEA P-54-440.

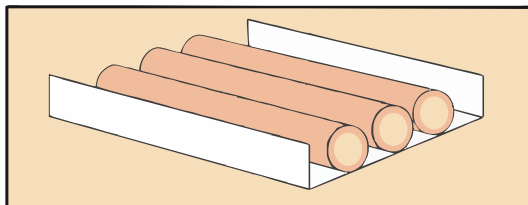

Ampacity Tablets

Three conductor cable in air

Any load factor from 30 to 100%.

The ampacities are for a single loaded cable in still air. In a group of loaded cables in close proximity in air, exposed or enclosed, follow the correction method shown on page 21.

Air ambient temperature 40°C.

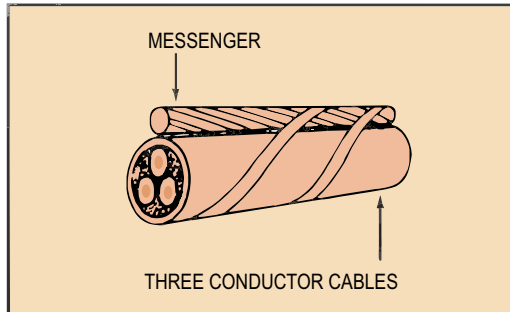

One cable in air per support or messenger

Copper

Table 6-22

Conductor Size AWG- kcmil	Non-Shielded	Shielded			
	600-5000 Volts Ampacity	2001-5000 Volts Ampacity		5001-35,000 Volts Ampacity	
	90° C (194°F)	90° C (194°F)	105°C (221°F)	90° C (194°F)	105°C (221°F)
8	59	59	66	—	—
6	79	79	88	93	105
4	104	105	115	120	135
2	138	140	154	165	185
1	161	160	180	185	210
1/0	186	185	205	215	240
2/0	215	215	240	245	275
3/0	249	250	280	285	315
4/0	287	285	320	325	360
250	320	320	355	360	400
350	394	395	440	435	490
500	487	485	545	535	600
750	615	615	685	670	745
1000	707	705	790	770	860

Aluminum

Conductor Size AWG- kcmil	Non-Shielded	Shielded			
	600-5000 Volts Ampacity	2001-5000 Volts Ampacity		5001-35,000 Volts Ampacity	
	90° C (194°F)	90° C (194°F)	105°C (221°F)	90° C (194°F)	105°C (221°F)
8	46	46	51	—	—
6	61	61	68	72	80
4	81	81	90	95	105
2	108	110	120	125	145
1	126	125	140	145	165
1/0	145	145	160	170	185
2/0	168	170	185	190	215
3/0	194	195	215	220	245
4/0	224	225	250	255	285
250	250	250	280	280	315
350	309	310	345	345	385
500	385	385	430	425	475
750	495	495	550	540	600
1000	584	585	650	635	705

Ampacity Tablets

Three single conductor cables in conduit — in air

Closed shield operation. Shields bonded and grounded at multiple points. Any load factor from 30 to 100%.

One triplexed cable or three single conductor cables in a conduit.

The load ratings are for a single, loaded cable in still air. In a group of loaded cables in close proximity in air, exposed or enclosed, follow the correction method shown on page 21.

Air ambient temperature 40°C.

One isolated conduit — three single or triplexed conductors — in air

Copper

Table 6-23

Conductor Size AWG- kcmil	Non-Shielded	Shielded			
	600-5000 Volts Ampacity	2001-5000 Volts Ampacity		5001-35,000 Volts Ampacity	
	90° C (194°F)	90° C (194°F)	105°C (221°F)	90° C (194°F)	105°C (221°F)
8	55	55	61	—	—
6	75	75	84	83	93
4	97	97	110	110	120
2	130	130	145	150	165
1	156	155	175	170	190
1/0	179	180	200	195	215
2/0	204	205	225	225	255
3/0	242	240	270	260	290
4/0	278	280	305	295	330
250	317	315	355	330	365
350	384	385	430	395	440
500	477	475	530	480	535
750	598	600	665	585	655
1000	689	690	770	675	755

Aluminum

Conductor Size AWG- kcmil	Non-Shielded	Shielded			
	600-5000 Volts Ampacity	2001-5000 Volts Ampacity		5001-35,000 Volts Ampacity	
	90° C (194°F)	90° C (194°F)	105°C (221°F)	90° C (194°F)	105°C (221°F)
8	43	43	48	—	—
6	58	58	65	65	72
4	76	76	85	84	94
2	102	100	115	115	130
1	122	120	135	130	150
1/0	139	140	155	150	170
2/0	159	160	175	175	200
3/0	189	190	210	200	225
4/0	217	215	240	230	260
250	249	250	280	255	290
350	303	305	340	310	350
500	381	380	425	385	430
750	488	490	545	485	540
1000	578	580	645	565	640

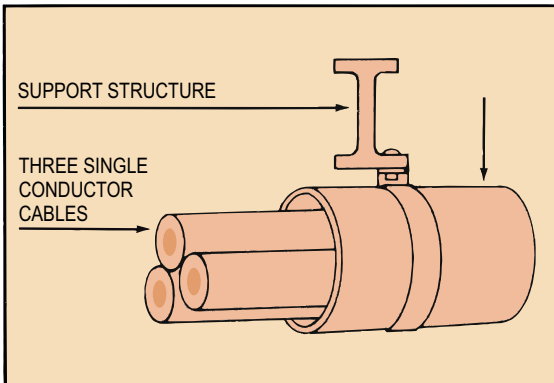

Ampacity Tablets

Three conductor cable — conduit in air

Any load factor from 30 to 100%.

The ampacities are for a single, loaded cable in still air. In a group of loaded cables in close proximity in air, exposed or enclosed, follow the correction method shown on page 21.

Air ambient temperature 40°C.

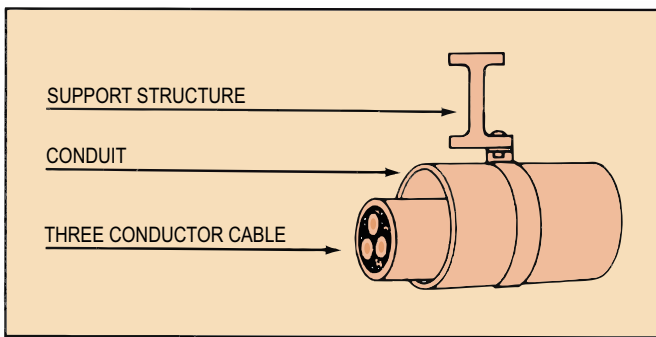

One isolated conduit — three conductors in air Copper

Table 6-24

Conductor Size AWG- kcmil	Non-Shielded		Shielded		
	600-5000 Volts Ampacity	2001-5000 Volts Ampacity		5001-35,000 Volts Ampacity	
		90° C (194°F)	90° C (194°F)	105° C (221°F)	90° C (194°F)
8	52	52	58	—	—
6	69	69	77	83	92
4	91	91	100	105	120
2	123	125	135	145	165
1	141	140	155	165	185
1/0	166	165	185	195	215
2/0	190	190	210	220	245
3/0	218	220	245	250	280
4/0	255	255	285	290	320
250	282	280	315	315	350
350	348	350	390	385	430
500	425	425	475	470	525
750	524	525	585	570	635
1000	590	590	660	650	725

Aluminum

8	41	41	46	—	—
6	53	53	59	64	71
4	71	71	79	84	94
2	96	96	105	115	125
1	110	110	125	130	145
1/0	130	130	145	150	170
2/0	149	150	165	170	190
3/0	170	170	190	195	220
4/0	200	200	225	225	255
250	221	220	245	250	280
350	274	275	305	305	340
500	341	340	380	380	425
750	432	430	480	470	520
1000	504	505	560	550	615

NEC Code installations *Ampacity at 75°C conductor temperature 30°C ambient

Table 6-25

Conductor Size	600V			
	One to 3 Conductors in Raceway, Cable or Direct Burial		Single Conductor in Free Air	
AWG or KCMIL	AMPERES			
	CU	AL	CU	AL
14	15	—	20	—
12	20	15	25	20
10	30	25	40	30
8	50	40	70	55
6	65	50	95	75
4	85	65	125	100
2	115	90	170	135
1	130	100	195	155
1/0	150	120	230	180
2/0	175	135	265	210
3/0	200	155	310	240
4/0	230	180	360	280
250	255	205	405	315
300	285	230	445	350
350	310	250	505	395
400	335	270	545	425
500	380	310	620	485
600	420	340	690	540
700	460	375	755	595
750	475	385	785	620
800	490	395	815	645
900	520	425	870	700
1000	545	445	935	750
1250	590	485	1065	855
1500	625	520	1175	950
1750	650	545	1280	1050
2000	665	560	1385	1150

Correction factors for room temperatures over 30°C (86F) ambient

40°C 104°F	.88	.88
45°C 113°F	.82	.82
50°C 122°F	.75	.75
55°C 131°F	.67	.67
60°C 140°F	.58	.58
70°C 158°F	.33	.33

*Ampacities are maximum allowed by the National Electrical Code. Sizes of conductors used on all normal electrical circuits in buildings may be determined on the basis of N.E.C. requirements taking into account voltage drop and operating efficiency at lower conductor temperatures.

Installation Practices*

Methods for Determining Conduit Sizes

Conduits or ducts should be properly constructed having smooth walls and of adequate size as determined by the overall cable diameter and recommended percentage of fill of conduit area.

Dimensions of conduit (Sch. 40)

Table 7-1

Nominal size conduit inches	Internal diameter inches	Wall Thickness inches	Area square inches
1	1.049	0.133	0.86
1 1/4	1.380	0.140	1.50
1 1/2	1.610	0.145	2.04
2	2.067	0.154	3.36
2 1/2	2.469	0.203	4.79
3	3.068	0.216	7.38
3 1/2	3.548	0.226	9.90
4	4.026	0.237	12.72
5	5.047	0.258	20.00
6	6.065	0.280	28.89

For groups or combinations of cables it is recommended that the conduit or tubing be of such size that the sum of the cross-sectional areas of the individual cables will not be more than the percentage of the interior cross-sectional area of the conduit or tubing as shown in the following tables.

Maximum percent internal area of conduit or tubing

Table 7-2

	Number of cables				
	1	2	3	4	Over 4
Max % Fill	53	31	40	40	40

* This section summarizes procedures, calculations, and recommendations required for proper installation practices.

For more information consult Okonite's "Installation Practices for Cable Raceway Systems" handbook.

Maximum percent internal diameter of conduit or tubing

Table 7-3

	Number of cables			
	1	2	3	4
Max % Diameter	72.8	39.3	36.5	31.6

Maximum allowable diameter (in inches) of individual cables in given size of conduit

Table 7-4

Nominal size conduit	All cables of same outside diameter			
	Number of cables having same O.D.			
	1	2*	3*	4*
1/2	0.453	0.244	0.227	0.197
3/4	0.600	0.324	0.301	0.260
1	0.763	0.412	0.383	0.332
1 1/4	1.010	0.542	0.504	0.436
1 1/2	1.173	0.633	0.588	0.509
2	1.505	0.812	0.754	0.653
2 1/2	1.797	0.970	0.901	0.780
3	2.234	1.206	1.120	0.970
3 1/2	2.583	1.395	1.296	1.121
4	2.930	1.583	1.470	1.273
5	3.675	1.985	1.844	1.595
6	4.416	2.385	2.215	1.916

NOTE: To determine the size conduit required for any number (n) of equal diameter cables in excess of four, multiply the diameter of one cable by $\sqrt{\frac{n}{4}}$

This will give the "equivalent" diameter of four such cables and the conduit size required for (n) cables may then be found by using the column for four cables.

*These diameters are based on percent fill only. The Jam Ratio, Conduit I.D. divided by one Cable O.D., should be checked to avoid possible jamming.

Conduit Sizes Maximum Pulling Tensions

Conduit size for combinations of cable with different outside diameters

This size conduit required for a group of cables of different sizes may be determined by calculating the equivalent diameter d'' and then finding the size required for this diameter in the tables on previous page. For 1 to 4 Cables:

d'' = Equivalent diameter of same number of cables all of same outside diameter having total area equal to total area of group of cables of different sizes (a fictitious diameter appearing in column corresponding to total number of cables ($n_1 + n_2 + n_m + \dots$))

n_1 = number of cables of diameter d_1

n_2 = number of cables of diameter d_2

n_m = number of cables of diameter d_m , etc.

$$d'' = \sqrt{\frac{n_1 d_1^2 + n_2 d_2^2 + n_m d_m^2 + \dots}{n_1 + n_2 + n_m + \dots}}$$

EXAMPLE: Find size conduit for 2 neoprene-sheathed cables having diameter of 1.20" and 1 cable having diameter 0.63".

$$d'' = \sqrt{\frac{2 \times (1.20)^2 + 1 \times (0.63)^2}{2 + 1}} = \sqrt{\frac{2.88 + .397}{3}} = 1.045$$

In the column for three cables a diameter of 1.045" is between 0.901" and 1.120". Therefore 3" conduit is required.

Maximum pulling tensions

The force required to pull cable into a duct or the maximum pulling length can be determined from the following:

A. The maximum stresses must not be exceeded when pulling a cable:

1. The maximum tension shall not exceed 0.008 times CM area when pulled with a pulling eye attached to the copper or aluminum conductors.

$$T_m = 0.008 \times n \times \text{CM}$$

T_m = maximum tension lb.

where

n = number of conductors in cable

CM = circular mil area of each conductor

The maximum tension for a 1/C shall not exceed the value calculated using the above listed formula or 6,000 lbs, whichever is lower. For 2 or more conductors, the tension shall not exceed the value calculated using the above listed formula or 10,000 lbs, whichever is lower.

2. The maximum stress for leaded cables shall not exceed 1500 lb./sq. inch of lead sheath area when pulled with a basket grip.

$$T_m = 4712 \, t(D-t)$$

where t = lead sheath thickness, inches

D = outside diameter of cable, inches

3. The maximum tension shall not exceed 1000 lbs. for non-leaded cables when pulled with a basket grip. (However, maximum stress calculated for item 1 cannot be exceeded.) For URO-J cables, with a properly installed basket grip, the maximum tension shall not exceed 10,000 lbs. This applies to single and multiple-conductor cable pulls.

4. The maximum tension at a bend shall not exceed 500 pounds times the radius of curvature of the duct expressed in feet. (But maximum tension calculated from items 1, 2 or 3 cannot be exceeded). Thus the minimum radius should not be less than $R(\text{ft}) = \frac{T}{500}$ where T is maximum tension calculated under A1, A2 or A3 or the radii in Tables 7-6 and 7-7.

B. The pulling tension in a given horizontal duct section may be calculated from the following.

1. For a straight section the pulling tension is equal to the length of the duct run multiplied by the weight per foot of the cable and the coefficient of friction which, will vary depending on lubrication used.

$$T = L \times w \times f$$

where T = total pulling tension

L = length of duct run in ft.

w = weight of cable in lbs. per ft.

f = coefficient of friction

2. For ducts having curved sections, the following formula applies.

$$T_{\text{out}} = T_{\text{in}} e^{fa}$$

where T_{out} = tension out of bend

T_{in} = tension into bend

f = coefficient of friction

e = naperian logarithm base 2.718

a = angle of bend in radians

To aid in solving the above formula, values of e^{fa} for specific angles of bend and coefficients of friction are listed in the Table 7-5 below. **For more precise values, consult Okonite's Installation Practices Manual.**

Table 7-5

Angle of bend degrees/radians	Values of e^{fa} for coefficients of friction $f=$		
	0.75	0.50	0.35
15/0.2618	1.22	1.14	1.10
30/0.5236	1.48	1.30	1.20
45/0.7854	1.80	1.48	1.32
60/1.0472	2.19	1.68	1.44
90/1.5708	3.25	2.20	1.73

For two or more cables for friction (f) use .5 for lubricated duct and .75 for dry duct. These factors include weight correction factor for maximum fill.

Maximum Pulling Tensions Example Problems

EXAMPLE

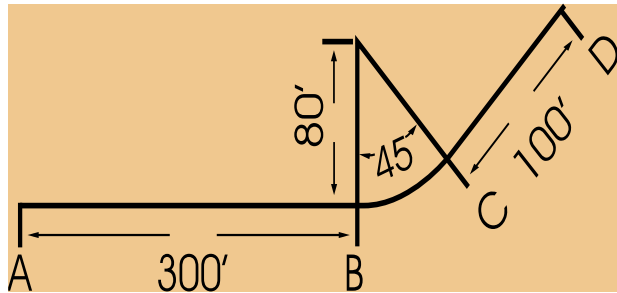

Size of Cable = 3/C-500 kcmil Copper Cdrs.,
9/64" (0.141") lead;
O.D. = 3.0"

Weight of Cable = 8 lb./ft.
Coefficient of friction = 0.5
Pulling from A to D

$$\begin{aligned} \text{Tension at B} &= T_1 = L_1 wf \\ &= T_1 = 300 \times 8 \times 0.5 = 1200 \text{ lb.} \end{aligned}$$

$$\begin{aligned} \text{Tension at C} &= T_1 e^{fa} \\ a &= 45^\circ = 0.7854 \text{ radians} \\ fa &= 0.3927 \\ e^{fa} &= 1.48 \end{aligned}$$

$$\text{Tension at C} = 1200 \times 1.48 = 1776 \text{ lb.}$$

$$\begin{aligned} \text{Tension C to D} &= T_2 = L_2 wf \\ T_2 &= 100 \times 8 \times 0.5 = 400 \text{ lb.} \\ T &= T_2 + T_1 e^{fa} = 400 + 1776 = 2176 \text{ lb.} \end{aligned}$$

Calculated Max. Tension
using pulling eye (A-1) = $0.008 \times 3 \times 500,000 = 12,000 \text{ lb.}$
Therefore, the 10,000 lb. limitation applies.

Permissible Max. Tension
using basket grip (A-2) = $4712 \times .141(3.0-0.141) = 1900 \text{ lb.}$
Permissible Max. Tension due to sidewall pressure limitation at curve BC (A-4) = $500 \times 80 = 40,000 \text{ lb.}$

Thus, it is seen cable must be pulled with an eye from A to D, as the tension exceeds that permissible for a basket grip.

$$\begin{aligned} \text{Pulling from D to A} \\ \text{Tension at C} &= 400 \text{ lb.} \\ \text{Tension at B} &= 400 \times 1.48 = 592 \text{ lb.} \\ \text{Total Tension at A} &= 1200 + 592 = 1792 \text{ lb.} \end{aligned}$$

This shows the cable could be pulled in this direction with either a pulling eye or basket grip.

CONCLUSIONS

A lower tension is obtained by placing the let-off reel at the end nearest the bend.

The radius of bend does not affect the total pulling tension, however, the pressure against the duct is affected by the radius of the bend. In this case, the minimum radius of bend if pulled from A is $1776/500 = 3.6 \text{ ft.}$, while if pulled from D is $592/500 = 1.2 \text{ ft.}$

EXAMPLE

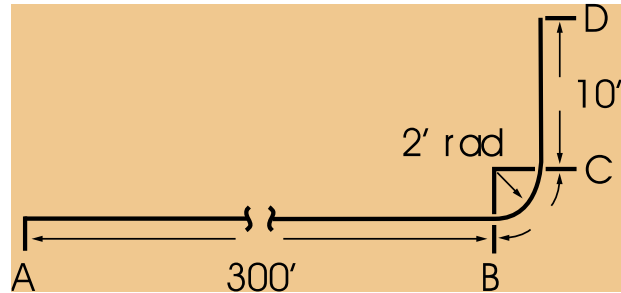

Size of Cable = 1 X 1000 kcmil Copper Cdr.
Weight of Cable = 6 lb./ft.
Coefficient of Friction = 0.5
Pulling from A to D

$$\begin{aligned} \text{Tension at B} &= 300 \times 6 \times 0.5 = 900 \text{ lb.} \\ e^{fa} &= 2.20 \end{aligned}$$

$$\begin{aligned} \text{Tension at C} &= 900 \times 2.20 = 1980 \text{ lb.} \\ \text{Tension at D} &= 10 \times 6 \times 0.5 + 1980 = 2010 \text{ lb.} \end{aligned}$$

It is seen that this exceeds 1000 lb. which is the maximum permissible tension for pulling grips so this must be pulled with a pulling eye which would permit a maximum tension of 6,000 lbs.

Maximum allowable tension at bend is $500 \times 2 = 1000 \text{ lb.}$ thus, it is seen that this cable cannot be pulled around this bend when pulled from A without exceeding the permissible pressure against the duct. It is therefore necessary to pull this cable from D.

$$\begin{aligned} \text{Pulling from D to A} \\ \text{Tension at C} &= 10 \times 6 \times 0.5 = 30 \text{ lb.} \\ \text{Tension at B} &= 2.2 \times 30 = 66 \text{ lb.} \\ \text{Tension at A} &= 900 + 66 = 966 \text{ lb.} \end{aligned}$$

This is satisfactory in all respects. The total tension does not exceed 1000 lb. and the tension at the curve does not exceed 1000 lb. so this cable can be pulled from D with a pulling grip.

The examples shown here are truncated demonstrations of pulling tension calculations. They do not take the weight correction factor into consideration. For more precise calculations, see Okonite publication, "Installation Practices for Cable Raceway Systems."

The following are minimum bending radii for insulated cables that apply to cable pulling and permanent training after completion of a pull. When pulling cable around conduit bends, sheaves or other curved surfaces, larger radii may be required to reduce the sidewall pressure to keep it under the maximum limit. Note that one wheel sheaves are listed as "diameter" and as such, their radii should be checked to confirm they meet the cables minimum bending "radius". In all cases, the minimum radii specified refers to the inner surface of the cable; not its axis.

Power and control cables without metallic shielding or armor

The minimum bending radii for both single-and multiple-conductor cable with or without lead sheath and without metallic shielding or armor are as follows:

Table 7-6

Thickness of Conductor Insulation Inches	Overall Diameter of Cable, Inches		
	1.000 and Less	1.001 to 2.000	2.001 and over
	Minimum Bending Radius as a Multiple of Cable Diameter		
.156 and less	4	5	6
.157 to .315	5	6	7
.316 and over		7	8

Twisted pair instrumentation cable

Table 7-7A

Type of Cable	Minimum Bending Radius as a Multiple of Cable Diameter
Armored, wire type or corrugated sheath or interlocked type	7*
Non-armored, without shielded conductors	6
Non-armored, metallized-polyester or braid shielded	8
Non-armored, flat or corrugated tape shielded	12**
*With shielded Conductors 8	
**For longitudinally applied corrugated shield with PVC jacket 15	

Power and control cables with metallic shielding or armor

Table 7-7

Type of Cable	Minimum Bending Radius as a Multiple of Cable Diameter	
	Power	Control
Armored, flat tape or wire type	12	12
Armored, smooth aluminum sheath, up to 0.75 inches cable diameter	10*	10*
0.76 to 1.5 inches cable diameter	12	12
over 1.5 inches cable diameter	15	15
Armored, corrugated sheath or interlocked type	7***	7
with shielded single conductor	12	12
with shielded multi-conductor	**	**
Non-armored, flat or corrugated tape shielded single conductor	12	12
triplexed	7	
tape shielded multi-conductor	**	**
multi-conductor overall tape shield	12	12
LCS with PVC jacket	15	15
Non-armored, flat strap shielded	8	—
Non-armored, wire shielded	Table 7-6	—
Non-armored, concentric neutral	8	—
* with shielded conductors 12		
** 12 times single conductor diameter or 7 times overall cable diameter — whichever is greater		
*** Also applies to non-shielded cables		
LCS = longitudinally applied corrugated shield		

Rubber jacketed flexible portable power and control cables used on take-up reels and sheaves

Table 7-8

Type of Cable	Minimum Bending Radius as a Multiple of Cable Diameter
0-5 kV	6
Over 5 kV	8

General precautions for installing wires and cables in conduit

Investigations have shown that failures often develop in all types of cable because of damage caused during installation by carelessness, inexperience and failure to observe certain simple precautions. For the benefit of the many new workers involved in electrical work and in the interests of eliminating such preventable causes of electrical shutdowns and loss of production, we suggest the following procedures:

Before Pulling Wire: Observe all National Electric Code rules regarding installation. Check the conduit and wire sizes and actual overall diameters to be sure the approved "fill" will not be exceeded. Don't "crowd" the conduit.

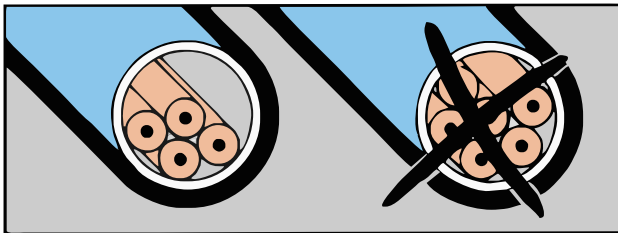

As in the case of any type of wire, when difficult runs are encountered, consideration should be given to the use of larger conduits or additional pull boxes. Pull a short mandrel or plug closely approximating the diameter of the conduit through to loosen any burrs, and check obstructions. Follow it up with a swab to clean out any remaining dirt or foreign matter.

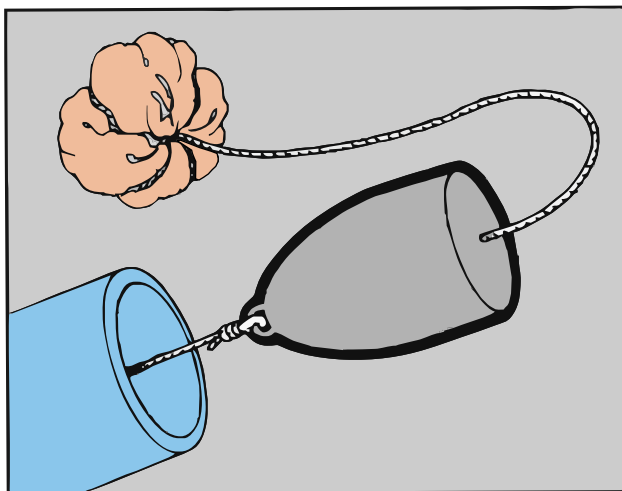

Hints on lubrication to make pulling easier

Any of the following simple methods of lubricating wires as they enter the conduit apply to thermosetting or thermoplastic jacketed wires and cables, but are also suitable for ordinary braided wires and cables.

1. Use a UL listed, commercially available lubricant compatible with the cable outer surface. Petroleum grease is not acceptable.
2. For long and difficult runs, prelubricate the conduit itself at the time the mandrel or plug is pulled through.

While Pulling Wire: Always have a person feed wire straight into conduit by hand or, for large conductors, over a large diameter sheave, avoiding short bends, sharp edges and "crossovers".

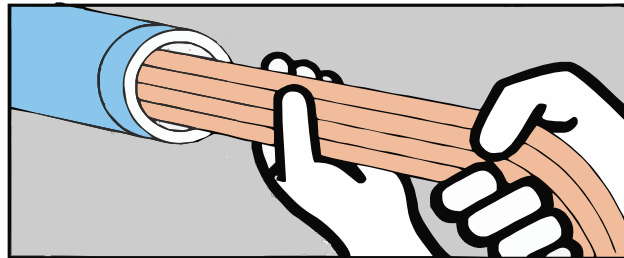

Remove all lashings used for temporary bunching of individual wires before they enter conduit. Lead-out wires at all pull boxes and conduits feeding them in again for next run. Never pull directly around short right-angled bends.

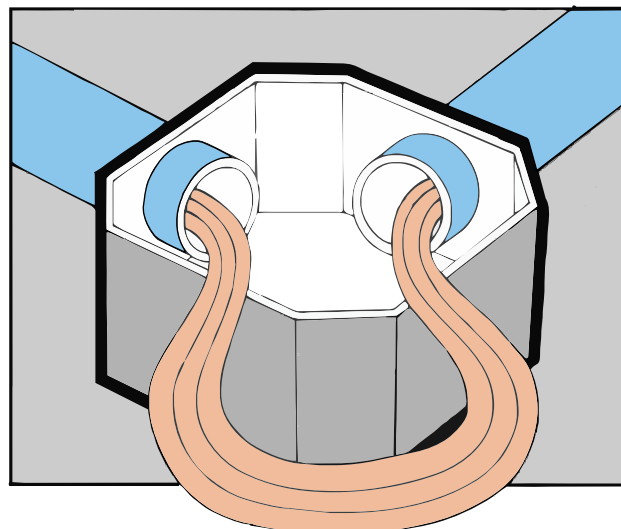

After Pulling Wire: Seal exposed ends with a heat shrink/cold shrink end cap or rubber tape (vinyl tape is not acceptable) to prevent moisture entering the cable pulled and the wire left on coil or reel.

For Switchboard and Similar Open Wiring: When binding groups of wires — especially non-braided wire — use wide tape or straps with rounded edges instead of narrow strings so as to avoid cutting or deforming the insulation at the point of contact.

Preferred practice for burying cables directly in the earth

Regardless of the type of cable you bury underground — whether it has a thermoset jacket, thermoplastic jacket or metallic armor — ordinary precautions in its installation will extend cable life and prevent service interruptions caused by mechanical damage.

Observe these two basic principles:

- (a) Keep rocks and other rough material away from cable. This will prevent bruising or deformation of the coverings if extraordinary pressures develop.
- (b) Pack soft fill around cable to prevent stone bruises and cuts. Incidentally, this improves heat dissipation which will increase cable efficiency and prolong its life.

Follow this procedure during installation

1. Dig trench deep enough (per NEC or NESC requirements) so cable will not be disturbed by plowing, surface digging, paving or excavation and will be below frost level.
2. Use a bedding of sand or rock-free screened fill as a cushion. Care should be taken that the fill is free from rotting wood or organic matter that might attract insects. Lay the cable on this bedding, permitting it to “snake” slightly in the trench to allow slack when earth settles.

Typical Direct Buried Detail

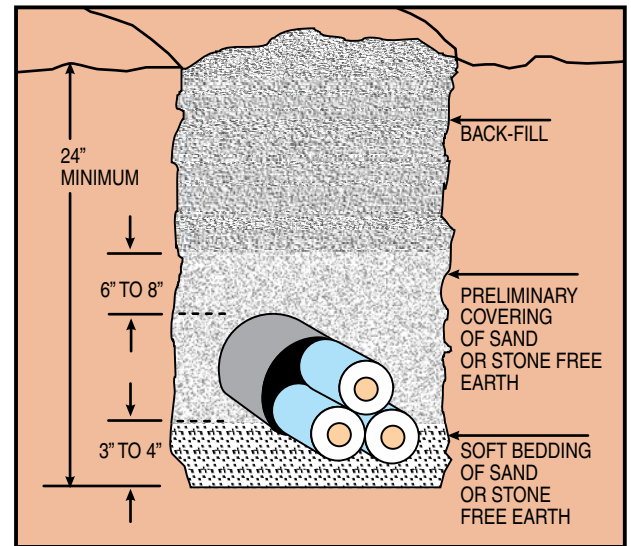

In general, it is preferable to use a jacketed multiconductor cable or a metallic tape if it is a single conductor cable, for direct burial, since this design offers a more rugged construction, is easier to install and prevents trouble from crossovers or stone bruises. A metallic tape of sufficient thickness is recommended for environments where termites or similar insects or small rodents may be encountered. The extra cost of the multiconductor cable design is often offset by use of a narrower trench and the reduced possibility of damages and subsequent outages and repairs.

If single conductor cables are laid in a trench, it is desirable to keep them separated uniformly, about six inches between centers, so earth and sand can be filled in around them. Be certain there are no crossovers.

3. After the cable is laid, and before back-filling, cover the cable with sand or soft earth, free from stones, rocks or other material that might be forced against the cable during back-filling, or when settling or frost-heaving disturbs the surrounding earth.
4. These preventative measures are desirable for all types of underground cable, whether metallic or nonmetallic. The extent of the precautions may vary from one installation to the next depending on the type of soil or the likelihood of disturbance.

Procedures

In urban areas or where a great deal of digging and excavating occurs, it is helpful to lay a protective covering on the soft fill about 6-8 inches above the cable to protect it and warn workmen of its presence. Such added protection is particularly desirable with unarmored cable. Strips of heavy woven galvanized wire fencing or concrete slabs laid on soft rock-free fill at least 6 inches above the cable are preferred where mechanical protection is necessary.

Under highways and railroad rights-of-way, it is usually best to pull the cable through a pipe or conduit. This should be taken into careful consideration when determining current carrying capacities as the temperature will be higher here than where directly buried.

Handling and storage recommendations

On receipt, cable protective covering should be inspected for evidence of damage during shipment. A report should immediately be made to carrier if evidence of damage is found.

Unloading should be accomplished so that equipment used does not contact cable surface, and in the case of protective wrap that the equipment does not contact the protective wrap. If unloading is accomplished by crane, either a cradle supporting the reel flanges or a shaft through the arbor hole should be used. If a fork lift is utilized, the forks must lift the reel at 90° to the flanges and must be long enough to make complete lifting contact with both flanges. Under no circumstances should the forks contact the cable surface or protective wraps.

If an inclined ramp is used for unloading, the ramp must be wide enough to contact both flanges completely and stopping of the reels at the bottom shall be accomplished by using the reel flanges and not the surface of the cable.

Under no circumstances should reels be dropped from the delivering vehicle to the ground.

Reels should be stored on a hard surface so that flanges do not sink into the earth and allow the weight of the reel and cable to rest on the cable surface.

Reels should never be stored on their sides.

Reels should be stored in an area where construction equipment, falling or flying objects or other materials will not contact the cable.

Cable should be stored in an area where chemicals or petroleum products will not be spilled or sprayed on the cable. The bottom and inner turns of cable with unjacketed sheath or armor (aluminum or steel) which remain continuously wet

will corrode. It is recommended that these reels be stored indoors.

When a reel of cable is rolled from one point to another, care must be taken to see that there are no objects on the surface area which could contact or damage the cable surface or protective wrap. The reel should be rolled in the correct direction to prevent loosening of the cable on the reel.

Cable should be stored in an area away from open fires or sources of high heat.

If a length of cable has been cut from the reel, the cable end should be immediately resealed to prevent the entrance of moisture.

When cables are to be installed in cold weather, they should be kept in heated storage for a least 24 hours before installation and not installed at temperatures lower than the following:

Type of Insulation or Jacket	Minimum Temperature for Installation
CPE (TP)	-30 C -22 F
CPE (TS)	-40 C -40 F
EPR	-40 C -40 F
ETFE	-65 C -85 F
CSPE (Hypalon)	-20 C -4 F
Neoprene	-20 C -4 F
PE	-40 C -40 F
PVC	-10 C 14 F
PVC (Arctic Grade)	-40 C -40 F
TPPO (LS/ZH)	-30 C -22 F
XLPO (LS/ZH)	-35 C -31 F
XLPE	-40 C -40 F

CPE-Chlorinated Polyethylene
 CSPE (Hypalon)-Chlorosulfonated Polyethylene
 EPR-Ethylene Propylene Rubber
 ETFE (Tefzel)-Modified Ethylene Tetrafluoroethylene
 PE-Polyethylene
 PVC-Polyvinyl Chloride
 TPPO-Thermoplastic Polyolefin
 XLPO-Cross Linked (Thermoset) Polyolefin
 XLPE-Cross Linked Polyethylene
 TP-Thermoplastic
 TS-Thermoset
 LS-Low Smoke
 ZH-Zero Halogen

For jacket performance data, see page 55.

Borehole Cable Safety Factor Calculations

Factors of safety in cables under mechanical tension

Following are the recommended factors of safety (ratio of breaking strength of cable to cable weight) in vertical risers, borehole and aerial cable.

- Armored Borehole and Mine Shaft Cable · · · F = 5
- Unarmored Borehole and Mine Shaft Cable · F = 7
- Armored Vertical Riser Cable · · · · · F = 7

Power conductors for unarmored borehole and mine shaft cables shall be stranded annealed coated or uncoated copper provided the minimum safety factor is not less than 7 when calculated by the following formula. If the minimum safety factor is less than 7, medium hard drawn copper shall be used but in no case shall the factor of safety be less than 7.

$$F = \frac{AT}{W}$$

- Where
- F = Factor of safety
 - T = Tensile strength of materials in pounds per square inch (24,000 for annealed copper, 40,000 for medium hard-drawn copper and 50,000 for wire armor)
 - A = Area of the power conductors in square inches or area of wire armoring
 - W = Weight of cable in pounds

Examples of calculations for determining the maximum length of borehole cable that may be suspended from one end are shown below:

Given: 3/C, 4/0, Borehole cable unarmored, 5kVery
OD = 2.23 in W = 4.51 lb. per foot

For Unarmored Borehole Cable:

$$\text{Area of one conductor} = \frac{\pi}{4} (211,600 \text{ CM} \times 10^{-6}) = .166 \text{ sq. in.}$$

For Annealed copper:

$$7 = \frac{(3 \times .166) (24,000)}{W} \quad W = 1710 \text{ lb.}$$

$$\text{Length of cable} = \frac{1710 \text{ lb.}}{4.51 \text{ lb./ft.}} = 379 \text{ ft.}$$

For Medium Hard Drawn copper:

$$7 = \frac{(3 \times .166) (40,000)}{W} \quad W = 2850 \text{ lbs}$$

$$\text{Length of cable} = \frac{2850}{4.51} = 630 \text{ ft.}$$

Given: 3/C, 4/0, Borehole cable armored, 5kVery

- OD = 2.62 in.
- Size armor wire - #6 BWG
- Number of Armor wires - 36
- W = 8.58 lb. per foot

For Armored Cable:

$$\begin{aligned} \#6 \text{ Bwg: } OD &= .203'' \\ \text{Area of one wire} &= \frac{\pi}{4} (.203)^2 = .0324 \text{ sq. in.} \\ 5 &= \frac{(.0324 \times 36) \times 50,000}{W} \quad W = 11,651 \text{ lbs.} \\ \text{Length of cable} &= \frac{11,651 \text{ lb.}}{8.58 \text{ lb./ft.}} = 1,358 \text{ ft.} \end{aligned}$$

Continuous support by clamps:

A useful formula for determining the spacing of cable clamps is:

$$S = \frac{9 D L}{W}$$

- S = Distance between clamps in ft.
- D = Cable diameter in inches
- L = Clamp length in inches
- W = Weight per foot of cable in lbs.

Galvanized steel wire

Table 7-9

# Bwg	Diam. in Mils	Approx. wt. in pounds per 1000 ft.	Approx. Breaking* Stress in Pounds	Resistance in Ohms at 68°F Per 1000 ft.
4	238	153	2,225	1.52
6	203	112	1,619	2.09
8	165	74	1,069	3.16
10	134	49	705	4.79
12	109	32	467	7.24
14	83	19	271	12.44

*Based on a stress of 50,000 psi.

Procedures

Sag and tension calculations for aerial cables

The sag and tension are based on the formulas for a parabola which are approximately the same as for a true catenary for small deflections. This well known formula is:

$$t = \frac{s^2 W}{8d}$$

where t = horizontal tension in messenger (lbs.)*
s = span length (ft.)
w = weight of complete cable including messenger (lbs. per foot)
d = sag (ft.)

*Use 50% of messenger breaking strength for Heavy Loading and 25% of breaking strength for Normal Loading.

The total tension in the messenger at the support is the horizontal tension plus the vertical component due to the dead load. The vertical component has been neglected.

Some typical messenger breaking strengths are given below.

For more information see ICEA Publication P-79-561 "Guide for Selecting Aerial Cable Messengers and Lashing Wires".

Determination of ice and wind loading

Ice and wind loading are determined by geographical location. The United States is divided into three districts for which standard loading conditions are specified in the National Electric Safety Code. The loadings for the various districts are as follows:

Loading District	Heavy	Medium	Light
Radial Thickness of Ice (in.)	1/2	1/4	0
Horizontal Wind Pressure (lbs/sq.ft)	4*	4*	9**
Temperature (F)	0	15	30
Constant-k (lbs/ft.)	0.31	0.22	0.05

* 40 mph ** 60 mph wind speed

The resultant weight of loaded cables is calculated as follows:

$$i = \text{Weight of ice loading (lbs/ft.)} = 1.24 t (D + t)$$

t = Thickness of ice (inches)

D = Diameter of cable (inches)

P = Force due to wind (lbs./sq. ft.)

$$h = \text{Force due to wind (lbs/ft.)} = \frac{P(D + 2t)}{12}$$

w' = Weight of unloaded cable

w'' = Vertical weight of loaded cable

$$w'' = w' + i$$

The loaded weight of the cable is the resultant of the vertical and horizontal weights plus the proper constant.

w''' = Resultant weight of loaded cable

$$w''' = \sqrt{(w'' + i)^2 + h^2} + k$$

Messenger characteristics

Table 7-10

Nominal Messenger Size	EHS Copperclad (30%)			Aluminum-Clad Steel			EHS Galvanized Steel			Stainless Steel Type 316		
	lb/ft	Breaking Strength (lbs)	Area x Modulus (ae)	lb/ft	Breaking Strength (lbs)	Area x Modulus (ae)	lb/ft	Breaking Strength (lbs)	Area x Modulus (ae)	lb/ft	Breaking Strength (lbs)	Area x Modulus (ae)
1/4" 7x	—	—	—	.104	6301	825700	.121	6650	871000	.135	7650	1060000
5/16" 7x	.204	9196	1313000	.165	10020	1313000	.205	11200	1502000	.212	11900	1665000
3/8" 7x	.324	13890	2088000	.385	15930	2088000	.273	15400	1821000	.286	16200	2217000
7/16" 7x	.409	16890	2633000	.433	19060	2633500	.399	20800	2770000	.416	23400	3234000
1/2" 7x	.515	20460	3319000	.486	22730	3319000	.517	26900	3442000	.535	30200	4190000
9/16" 7x	.650	24650	4186000	.546	27030	4186000	.671	35000	4469000	—	—	—
9/16" 19x	.700	30610	4496000	—	—	—	.637	33700	4383000	.670	36200	5240000

Coefficient of Linear Expansion .0000072, Except Stainless Steel = .0000088 Per Degree F.

Typical example of sag and tension calculations

Cable: 3 conductor 2/0 Self-Supporting Cable rated at 5 kV.
 Messenger: 3/8" Extra High Strength (30% Conductivity) Copperweld
 Ruling Span: 125 ft.
 Normal Tension: 3470 lbs. (25% of ultimate strength)
 To find the sag at 60F and the sag and tensions under heavy loading conditions:
 Weight of complete cable $w' = 2.712$ lbs./ft. (2712 lbs./1000')
 Diameter of cable (circumscribed circle) $D = 2.50"$
 Normal Tension $T = 3470$ lbs.
 Area x Modulus, $ae = 2,088,000$
 Calculate normal sag at 60°F.
 Span $S = 125$ ft.

$$\frac{Sw'}{T} = \frac{125 \times 2.712}{3470} = 0.0976$$

From Table on page 49 note that sag factor corresponding to $\frac{Sw'}{T} = 0.0976$ is 0.01221

$$\text{Sag} = 0.01221 \times 125 = 1.530 \text{ ft.} \\ = 18.3 \text{ inches}$$

To find sag and tension under heavy loaded conditions:

Heavy loading — **1/2" radial ice and 4 lb. sq. ft. horizontal wind force at 0 F.**

$$\begin{aligned} \text{Constant } k &= 0.31 \\ \text{Weight of ice loading, } i &= 1.24 \times t(D + t) \\ &= 1.24 \times .5 (2.50 + .5) \\ &= 1.860 \text{ lbs.} \\ \text{Horizontal force, } h &= \frac{P(D + 2t)}{12} \\ &= 1.167 \end{aligned}$$

$$\begin{aligned} \text{Vertical weight of loaded cable, } w'' &= w' + i \\ &= 2.712 + 1.860 \\ &= 4.572 \text{ lbs} \end{aligned}$$

$$\begin{aligned} \text{Resultant force, } w''' &= \sqrt{h^2 + (w' + i)^2} + k \\ &= \sqrt{1.167^2 + 4.572^2} + .31 \\ &= 4.72 + .31 = 5.03 \end{aligned}$$

The procedure for calculating the sag and tension under loaded conditions consists of finding the unstressed length of the cable, changing its length for the change in temperature and then stressing the cable for the new loaded conditions and determining the new sag and tension.

In the above calculations of normal sag we calculated

$$\frac{Sw'}{T} = 0.0976$$

Calculate Elongation factor

$$\frac{Sw'}{ae} = \frac{125 \times 2.712}{2,088,000} = 0.000162$$

From the curves on pages 48 and 49 determine the unstressed length factor for the abscissa $\frac{Sw'}{ae} = 0.000162$

$$\text{and the curve } \frac{Sw'}{T} = 0.0976$$

This is found to be 0.99873 = unstressed length factor
 Correct this from 60F to 0 F.

Temperature correction factor of linear expansion .0000072/F.

$$\therefore \text{Correction of length factor} = -60 \times (.0000072) \\ = -.000432$$

$$\text{Unstressed length at 0 F.} = 0.99873 - 0.000432 \\ = 0.99830$$

Calculate elongation factor for loaded weight $w'' = 5.03$ lbs./ft.

$$\frac{Sw''}{ae} = \frac{125 \times 5.03}{2,088,000} = .000300$$

From the curves on pages 48 and 49 determine $\frac{Sw''}{T}$ for the

ordinate of 0.99830 and the abscissa of 0.000300.

This is found to be 0.126.

Calculate Tension T' under loaded conditions from

$$\frac{Sw''}{T'} = 0.126$$

$$T' = \frac{125 \times 5.03}{0.126} = 4990 \text{ lbs}$$

This is seen to be 35.9% of the Ultimate strength of the messenger.

The sag factor is determined from Table on page 47 corresponding to $\frac{Sw''}{T'} = 0.126$ and is found to be 0.01578

$$\text{Sag} = 0.01578 \times 125 = 1.970 \text{ ft.} = 23.6 \text{ inches.}$$

For stringing the cable it is usual practice to calculate the stringing tension (unloaded) for various temperatures and plot a curve for ready reference. The procedure is the same as in the above example using the unloaded cable weight. The work can be speeded by tabulating the calculations.

Stringing Temp. F	0	30	60	90
Correction for length	-0.00043	-0.00022	0	+0.00022

Unstressed length factor	.99830	.99851	.99873	.99895
--------------------------	--------	--------	--------	--------

For these values

$$\text{and } \frac{Sw'}{ae} = .000162$$

$$\text{find } \frac{Sw'}{T} = \begin{matrix} .082 & .090 & .098 & .106 \end{matrix}$$

Solving for

Stringing Tension T	4140	3760	3460	3200
---------------------	------	------	------	------

The sags may also be calculated if desired, but the spans usually vary so it is more convenient to pull the entire length of cable up to the desired tension rather than measuring the sag.

The above calculations are based on final stretch values. The messenger is usually over-stressed during installation so the final stretch values are more accurate than initial values.

Procedures

Sag Tables

Table 7-11

SW T	Sag Factor	SW T	Sag Factor	SW T	Sag Factor	SW T	Sag Factor	SW T	Sag Factor	SW T	Sag Factor	SW T	Sag Factor
.050	.006 25	.100	.012 51	.150	.018 81	.200	.025 14	.250	.031 54	.300	.038 00	.350	.044 56
.051	.006 37	.101	.012 64	.151	.018 93	.201	.025 27	.251	.031 66	.301	.038 13	.351	.044 69
.052	.006 50	.102	.012 76	.152	.019 06	.202	.025 40	.252	.031 79	.302	.038 26	.352	.044 82
.053	.006 62	.103	.012 89	.153	.019 19	.203	.025 52	.253	.031 92	.303	.038 39	.353	.044 95
.054	.006 75	.104	.013 02	.154	.019 31	.204	.025 65	.254	.032 05	.304	.038 52	.354	.045 08
.055	.006 87	.105	.013 14	.155	.019 44	.205	.025 78	.255	.032 18	.305	.038 65	.355	.045 22
.056	.007 00	.106	.013 27	.156	.019 56	.206	.025 91	.256	.032 31	.306	.038 78	.356	.045 35
.057	.007 12	.107	.013 39	.157	.019 69	.207	.026 03	.257	.032 44	.307	.038 91	.357	.045 48
.058	.007 25	.108	.013 52	.158	.019 82	.208	.026 16	.258	.032 56	.308	.039 04	.358	.045 61
.059	.007 37	.109	.013 64	.159	.019 94	.209	.026 29	.259	.032 69	.309	.039 17	.359	.045 75
.060	.007 50	.110	.013 77	.160	.020 07	.210	.026 42	.260	.032 82	.310	.039 30	.360	.045 88
.061	.007 62	.111	.013 90	.161	.020 20	.211	.026 54	.261	.032 95	.311	.039 43	.361	.046 01
.062	.007 75	.112	.014 02	.162	.020 32	.212	.026 67	.262	.033 08	.312	.039 56	.362	.046 14
.063	.007 87	.113	.014 15	.163	.020 45	.213	.026 80	.263	.033 21	.313	.039 70	.363	.046 28
.064	.008 00	.114	.014 27	.164	.020 58	.214	.026 93	.264	.033 34	.314	.039 83	.364	.046 41
.065	.008 13	.115	.014 40	.165	.020 70	.215	.027 05	.265	.033 47	.315	.039 96	.365	.046 54
.066	.008 25	.116	.014 52	.166	.020 83	.216	.027 18	.266	.033 60	.316	.040 09	.366	.046 67
.067	.008 38	.117	.014 65	.167	.020 96	.217	.027 31	.267	.033 72	.317	.040 22	.367	.046 81
.068	.008 50	.118	.014 78	.168	.021 08	.218	.027 44	.268	.033 85	.318	.040 35	.368	.046 94
.069	.008 63	.119	.014 90	.169	.021 21	.219	.027 56	.269	.033 98	.319	.040 48	.369	.047 07
.070	.008 75	.120	.015 03	.170	.021 34	.220	.027 69	.270	.034 11	.320	.040 61	.370	.047 21
.071	.008 88	.121	.015 15	.171	.021 46	.221	.027 82	.271	.034 24	.321	.040 74	.371	.047 34
.072	.009 00	.122	.015 28	.172	.021 59	.222	.027 95	.272	.034 37	.322	.040 87	.372	.047 47
.073	.009 13	.123	.015 40	.173	.021 72	.223	.028 08	.273	.034 50	.323	.041 00	.373	.047 61
.074	.009 25	.124	.015 53	.174	.021 84	.224	.028 20	.274	.034 63	.324	.041 13	.374	.047 74
.075	.009 38	.125	.015 66	.175	.021 97	.225	.028 33	.275	.034 76	.325	.041 27	.375	.047 87
.076	.009 50	.126	.015 78	.176	.022 10	.226	.028 46	.276	.034 89	.326	.041 40	.376	.048 01
.077	.009 63	.127	.015 91	.177	.022 22	.227	.028 59	.277	.035 02	.327	.041 53	.377	.048 14
.078	.009 75	.128	.016 03	.178	.022 35	.228	.028 71	.278	.035 15	.328	.041 66	.378	.048 27
.079	.009 88	.129	.016 16	.179	.022 48	.229	.028 84	.279	.035 28	.329	.041 79	.379	.048 41
.080	.010 00	.130	.016 29	.180	.022 60	.230	.028 97	.280	.035 40	.330	.041 92	.380	.048 54
.081	.010 13	.131	.016 41	.181	.022 73	.231	.029 10	.281	.035 53	.331	.042 05	.381	.048 67
.082	.010 26	.132	.016 54	.182	.022 86	.232	.029 23	.282	.035 66	.332	.042 18	.382	.048 81
.083	.010 38	.133	.016 66	.183	.022 98	.233	.029 35	.283	.035 79	.333	.042 32	.383	.048 94
.084	.010 51	.134	.016 79	.184	.023 11	.234	.029 48	.284	.035 92	.334	.042 45	.384	.049 07
.085	.010 63	.135	.016 92	.185	.023 24	.235	.029 61	.285	.036 05	.335	.042 58	.385	.049 21
.086	.010 76	.136	.017 04	.186	.023 36	.236	.029 74	.286	.036 18	.336	.042 71	.386	.049 34
.087	.010 88	.137	.017 17	.187	.023 49	.237	.029 87	.287	.036 31	.337	.042 84	.387	.049 47
.088	.011 01	.138	.017 29	.188	.023 62	.238	.029 99	.288	.036 44	.338	.042 97	.388	.049 61
.089	.011 13	.139	.017 42	.189	.023 74	.239	.030 12	.289	.036 57	.339	.043 10	.389	.049 74
.090	.011 26	.140	.017 55	.190	.023 87	.240	.030 25	.290	.036 70	.340	.043 24	.390	.049 88
.091	.011 38	.141	.017 67	.191	.024 00	.241	.030 38	.291	.036 83	.341	.043 37	.391	.050 01
.092	.011 51	.142	.017 80	.192	.024 13	.242	.030 51	.292	.036 96	.342	.043 50	.392	.050 14
.093	.011 63	.143	.017 92	.193	.024 25	.243	.030 64	.293	.037 09	.343	.043 63	.393	.050 28
.094	.011 76	.144	.018 05	.194	.024 38	.244	.030 76	.294	.037 22	.344	.043 76	.394	.050 41
.095	.011 89	.145	.018 18	.195	.024 51	.245	.030 89	.295	.037 35	.345	.043 90	.395	.050 55
.096	.012 01	.146	.018 30	.196	.024 63	.246	.031 02	.296	.037 48	.346	.044 03	.396	.050 68
.097	.012 14	.147	.018 43	.197	.024 76	.247	.031 15	.297	.037 61	.347	.044 16	.397	.050 82
.098	.012 26	.148	.018 55	.198	.024 89	.248	.031 28	.298	.037 74	.348	.044 29	.398	.050 95
.099	.012 39	.149	.018 68	.199	.025 02	.249	.031 41	.299	.037 87	.349	.044 42	.399	.051 08
.100	.012 51	.150	.018 81	.200	.025 14	.250	.031 54	.300	.038 00	.350	.044 56	.400	.051 22

Sag Calculating Charts

Table 7-12

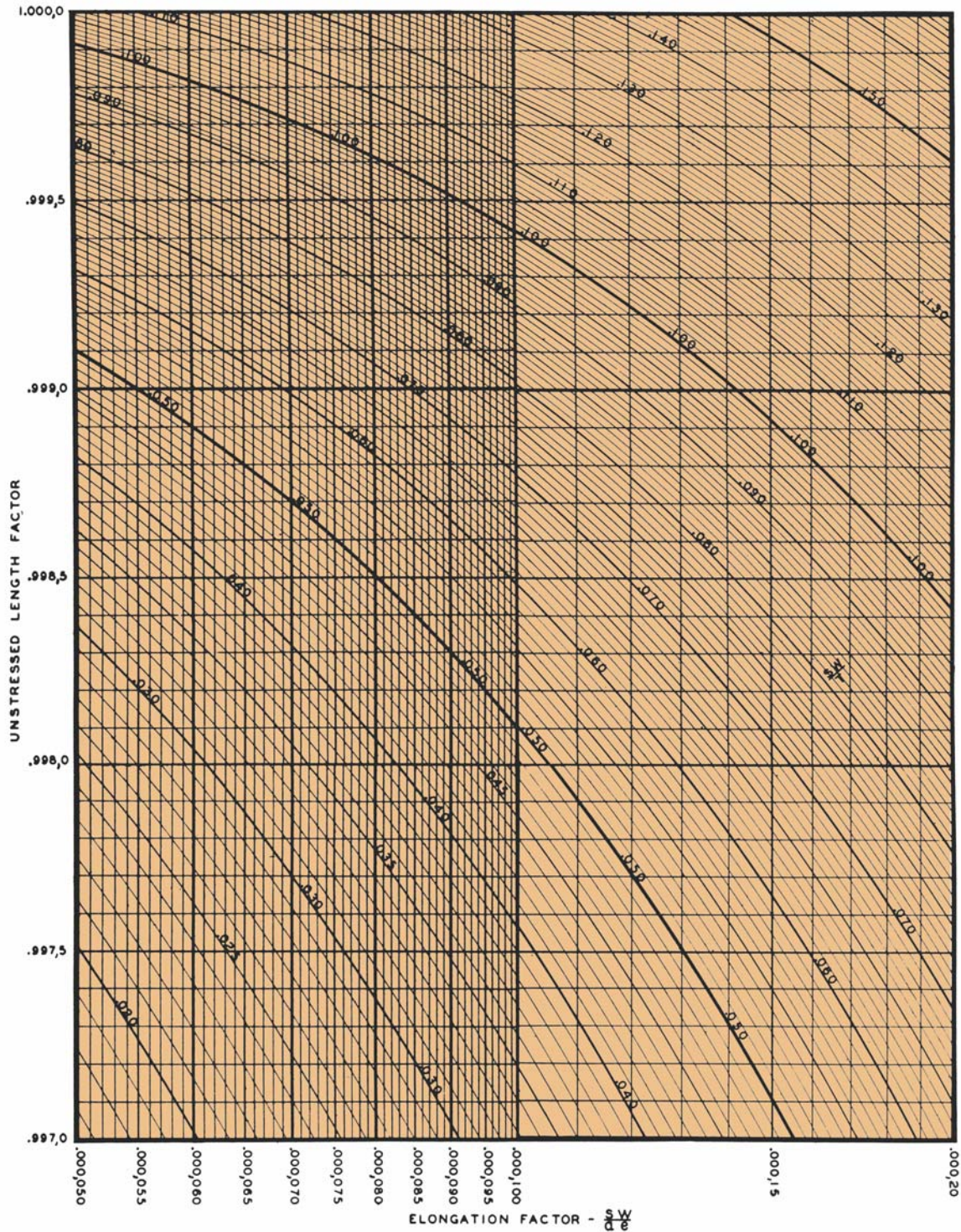

These charts reproduced through the courtesy of The FUSI Copperweld Steel Company

Procedures

Sag Calculating Charts

Table 7-13

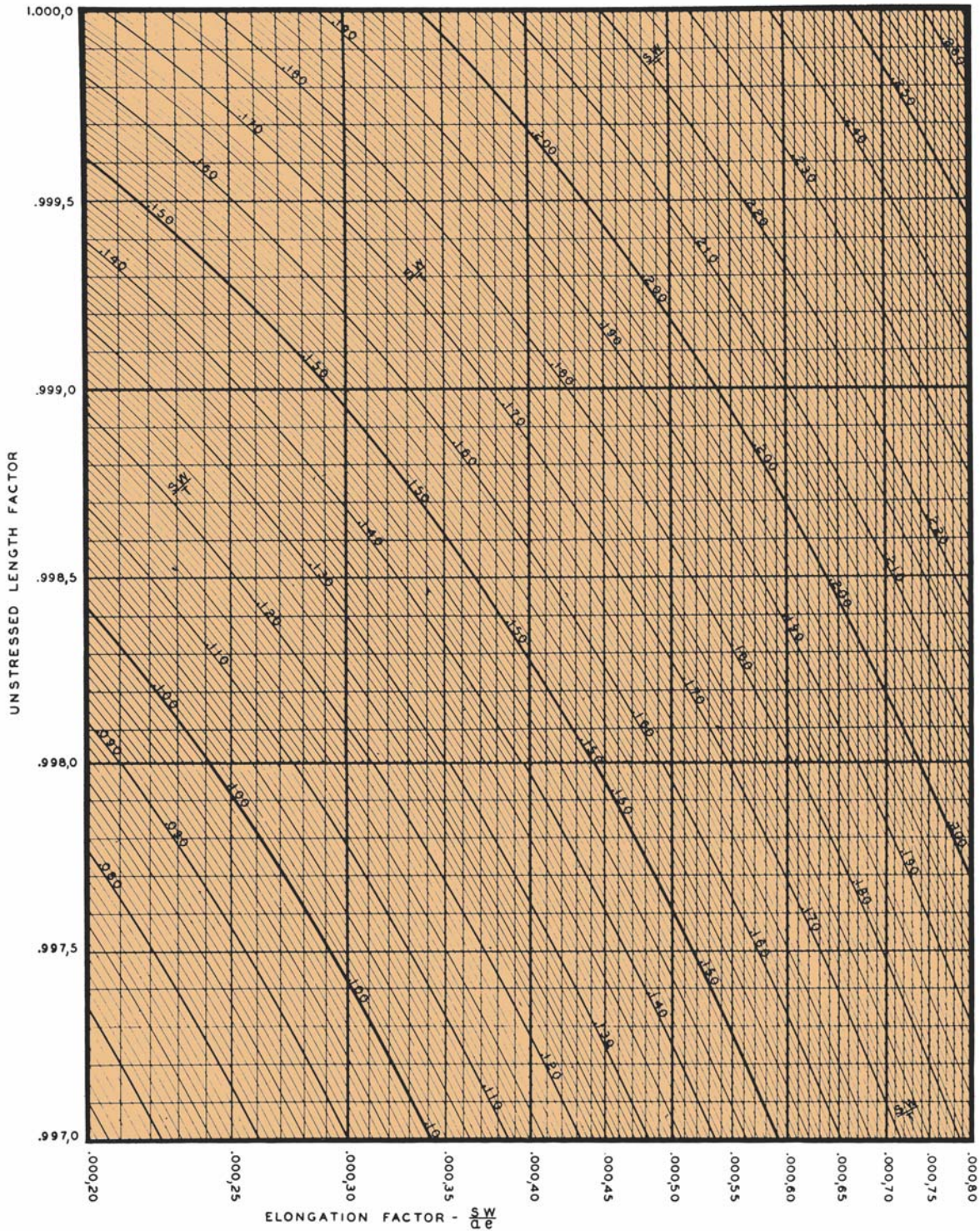

These charts reproduced through the courtesy of The FUSI Copperweld Steel Company

High voltage dc field testing

In 1996, the insulated conductor industry determined that dc withstand testing of the plastic (XLPE) insulation systems either in the cable factory as a routine production test or after installation as the higher voltage proof test was detrimental to the life of the insulation and therefore discontinued recommending dc testing. Medium voltage EPR insulating systems are not subject to the same aging characteristics and, therefore, can be dc tested as required in accordance with Tables 8-1, 8-2 and 8-3.

When an insulated cable arrives on the job site, the recipient should be able to confidently assume it will attain the designed service life. This means it must arrive free of internal discontinuities in the dielectric such as voids or inclusions, as well as freedom from air pockets at the interfaces between the shielding systems and the dielectric's surfaces. It is, however, the specter of mechanical damage, or substandard splicing and terminating that could cause the engineers responsible for continuity of service to desire a field applied proof test to establish the cable's serviceability. The time-honored methods of proof testing in the field involve high potential direct current (dc). The advantage of the dc test is obvious. Since the dc potential does not produce harmful discharge as readily as the ac, it can be applied at higher levels without risk or injuring good insulation. This higher potential can literally "sweep-out" far more local defects. The simple series circuit path of a local defect is more easily carbonized or reduced in resistance by the dc leakage current than by ac, and the lower the fault path resistance becomes, the more the leakage current increased, thus producing a "snow balling" effect which leads to the small visible dielectric puncture usually observed. Since the dc is free of capacitive division, it is more effective in picking out mechanical damage as well as inclusions or areas in the dielectric which have lower resistance.

Field tests should be utilized to assure freedom of electrical weakness in the circuit caused by such things as mechanical damage, unexpected environmental factors, etc. Field tests should not be used to seek out minute internal discontinuities in the dielectric or faulty shielding systems, all of which should have been eliminated at the factory, nor should the dc potential be excessive such that it would initiate punctures in otherwise good insulation.

For low voltage power and control cables it is general practice to use a megger for checking the reliability of the circuit. This consists essentially of measuring the insulation resistance of the circuit to determine whether or not it is high enough for satisfactory operation. For higher voltage

cables, the megger is not usually satisfactory and the use of high voltage testing equipment is more common. Even at the lower voltages, high voltage dc tests are finding increasing favor. The use of high voltage dc has many advantages over other types of testing procedure.

dc field acceptance testing

It is general practice, and obviously empirical, to relate the field test voltage upon installation by using a percentage of the factory applied dc voltage. This means that prior to being connected to other equipment, solid extruded dielectric insulated shielded cables rated 5kV and up may be given a field acceptance test of about 300 volts per mil. The actual test values recommended for the field acceptance test are presented below in Table 8-1. If other equipment is connected it may limit the test voltage, and considerably lower levels more compatible with the complete system would be in order.

High voltage field acceptance test prior to being placed in service

Table 8-1

Rated Voltage Phase to Phase	dc Hi-Pot Test (15 Minutes)		dc Hi-Pot Test	
	Wall - mils	Kv	Wall - mils	kV
5000	90	25	115	35
8000	115	35	140	45
15000	175	55	220	65
25000	260	80	320	95
28000	280	85	345	100
35000	345	100	420	125
46000	445	130	580	170
69000	650	195	650	195

Note: *If the leakage current quickly stabilizes, the duration may be reduced to 10 minutes.

Test limitations

The dc leakage can be affected by external factors such as heat, humidity, windage, and water level if unshielded and in ducts or conduits, and by internal heating if the cable under test had recently been heavily loaded. These factors make comparisons of periodic data obtained under different test conditions very difficult. If other equipment is connected into the cable circuit this makes it even more difficult. In the event hot poured compound filled splices and terminations are involved, testing should not be performed until they have cooled to room temperature.

High-Voltage Proof-Testing

The relays in high voltage dc test equipment are usually set to operate between 5 and 25 milliamperes leakage. In practice, the shape of the leakage curve, assuming constant voltage, is more important than either the absolute leakage current of a “go or no go” withstand test result.

Test Notes

From the standpoint of safety as well as data interpretation, only qualified personnel should run these high voltage tests

After the voltage has been applied and the test level reached, the leakage current may be recorded at one minute intervals. As long as the leakage current decreases or stays steady after it has leveled off, the cable is considered satisfactory. If the leakage current starts to increase, excluding momentary spurts due to supply-circuit disturbances, trouble may be developing and the test may be extended to see if the rising trend continues. The end point is, of course, the ultimate breakdown. This is manifested by an abrupt increase in the magnitude of the leakage current and a decrease in the test voltage. It should result in relay action to “trip” the set off the line, but this assumes the equipment has enough power to maintain the test voltage and supply the normal test current. Since the total current required is a function of cable capacity, condition of dielectric, temperature, end leakage and length, the test engineer must be sure that “relay action” actually signifies a local fault, rather than being merely an indication that the voltage had been applied too quickly or one of the other factors contributing to the total current had been the cause.

At the conclusion of each test, the discharge and grounding of the circuit likewise requires the attention of a qualified test engineer to prevent damage to the insulation and injury to personnel.

Maintenance proof testing

It may be justifiable in the case of important circuits to make periodic tests during the life of the installation to determine whether or not there had been significant deterioration due to severe and perhaps unforeseen operational or environmental conditions. The advantage of a scheduled proof test is, of course, that it can frequently “anticipate” a future service failure, and the necessary repair or renewal can be made without a service interruption, usually during a major shutdown.

Furthermore, a dc test failure is seldom burned-out, and visual analysis may disclose the cause and permit corrective action.

As a note of caution, once a complete circuit has been connected and all exposed ends sealed, it is not desirable when maintenance proof-testing to remove these seals, disconnect the conductors, and it is sometimes impossible to

provide “ends” with adequate clearance and length of insulation surface to permit high voltage testing even at the levels specified in Table 8-2. Further, there is the danger of mechanically injuring the dielectric during the seal removal and end preparation. This is a major reason why a “megger test” is often used in maintenance checking of the numerous circuits in a power plant.

High voltage maintenance test for cables in service less than ten years*

Table 8-2

Rated Voltage Phase to Phase	dc Proof Test (5 Minutes) kV
5000	20
8000	25
15000	40
25000	60
28000	65
35000	75
46000	100
69000	145

*For cables in service:

- 10 to 20 years - 80% of Table 8-2 levels.
- 20 + years - 1.5 x Rated Voltage to ground.

Frequency of tests

In the case of power plants, it is customary to schedule desired maintenance proof tests to coincide with planned major shutdowns. It is not necessary or justifiable to check every circuit each year. The following schedule in Table 8-3 is suggested as a guide.

Frequency of proof testing

Table 8-3

Class of Service	Period After Installation Acceptance Test		
	1st Maintenance test	2nd Maintenance Test	Period Between Succeeding Maintenance Test
Lighting	No Test	No Test	None
Normal	3 years	8-9 years	5-6 years
Critical	12 - 18 months	2-3 years	4 1/2 - 5 years

Other Test Methods

Test methods such as VLF (Very Low Frequency) and Field Partial Discharge Testing are acceptable alternatives to the DC Hipot test. Refer to IEEE Guides 400.2 and 400.3 for additional information.

Charging current

The charging current I of a single conductor insulated power cable can be obtained as follows;

$I = 2\pi f C e$ microamperes per 1000 feet

- Where: C = capacitance, picofarads per foot
- e = Voltage, conductor to neutral, kilovolts
- f = frequency, Hz

Capacitance of cables

The Capacitance of a one conductor shielded cable is

given by the formula $C = \frac{7.35 (SIC)}{\log \frac{D}{d}}$

- Where: C = capacitance of cable in picofarads per foot
- SIC = dielectric constant of the insulation
- D = diameter over insulation
- d = diameter under insulation

Typical Values of SIC

Polyvinyl Chloride (PVC)	3.5 - 8.0
EP Insulation	2.8 - 3.5
Polyethylene Insulation	2.3
Cross Linked Polyethylene	2.3 - 6.0

Insulation resistance

The insulation resistance (IR) of a cable can be estimated by the formula $IR = K \log \frac{D}{d}$

Where K = specific insulation resistance in megohms -1000 ft. at 60°F

D = diameter over insulation

d = diameter under insulation

IR = insulation resistance in megohms - 1000 ft. for the particular cable construction. IR is inversely proportional to the cable length so that a 500 ft. length will have twice the IR of 1000 ft. and similarly 2000 ft. will have one half the IR of 1000 ft.

Typical Values of K

Synthetic Rubber, Heat and Moisture Resisting 75°C	2000
EP Insulation (LV)	20000
EP Insulation (HV)	50000
Polyethylene	50000
PVC	2000
Cross Linked Polyethylene	20000

**Jacket materials selection chart
Relative performance data¹**

Table 9-1

Mechanical	PVC	TP-CPE	TS-CPE	TPPO	XLPO	PP	LLDPE	XLPE
Tensile Strength	Very Good	Good	Excellent	Good	Excellent	Excellent	Excellent	Excellent
Elongation	Very Good	Good	Excellent	Good	Excellent	Excellent	Excellent	Excellent
Flexibility	Excellent	Fair	Excellent	Fair	Excellent	Poor	Poor	Poor
Abrasion Resistance	Good	Very Good	Very Good	Very Good	Excellent	Excellent	Excellent	Excellent
Compression Resistance	Good	Excellent	Very Good	Excellent	Excellent	Excellent	Excellent	Excellent
Deformation Resistance (heated)	Fair	Fair	Excellent	Fair	Excellent	Poor	Poor	Good
Flame/Smoke/Halogen								
Resistance to Flame Propagation	Good	Excellent	Excellent	Very Good	Excellent	Poor	Poor	Poor
Fire Res	Yes	Yes	Yes	Yes	Yes	NO	NO	NO
Oxygen Index (%)	23-30	30-35	30-37	35-40	40-45	17-18	17-18	17-18
Halogen Content (%w)	26-25	18-20	16-18	0	0	0	0	0
Smoke Suppression	Very Poor	Very Poor	Very Poor	Excellent	Excellent	Fair	Very Poor	Fair
Low Smoke/Zero Halogen	NO	NO	NO	Yes	Yes	NO	NO	NO
Environmental								
Moisture	Good	Excellent	Excellent	Excellent	Excellent(1)	Excellent	Excellent	Excellent
Petroleum oils								
Motor oil	Good	Excellent	Good	Excellent	Good	Excellent	Excellent	Excellent
Fuel oil	Fair	Good ^B	Good	Good	Good	Excellent	Excellent ^C	Excellent
Crude oil	Fair	Good ^B	Good	Good	Good	Excellent	Excellent ^C	Excellent
Creosote	Poor	Good ^B	Fair	Good	Good	Excellent	Excellent ^C	Excellent
Paraffinic Hydrocarbons								
Gasoline	Good	Excellent ^A	Very Good	Very Good	Very Good	Excellent	Excellent ^B	Excellent
Kerosene	Good	Excellent ^A	Very Good	Very Good	Very Good	Excellent	Excellent ^B	Excellent
Alcohols	Fair	Excellent	Good	Excellent	Excellent	Excellent	Excellent	Excellent
Isopropyl								
Methanol (wood)								
Ethanol (grain)								
Mineral Acids	Excellent	Excellent	Excellent	Excellent	Excellent	Excellent	Excellent	Excellent
Sulfuric								
Nitric								
Hydrochloric								
Fixed Alkalis	Good	Excellent	Excellent	Excellent	Excellent	Excellent	Excellent	Excellent
Sodium hydroxide (lye)								
Potassium hydroxide (potash)								
Calcium hydroxide (lime)								

Minimum installation temperature, see page 45.

NOTE:

¹ Characteristics for generic versions of these materials are listed. Variations of these compounds are available to enhance properties such as arctic grade, fire resistance, etc...

^A Slight swelling at higher temperatures

^B Poor above 110°C

^C Slight swelling above 60°C

PVC = Polyvinyl Chloride

XLPO = Cross Linked Polyolefin

TPPO = Thermoplastic Polyolefin

TS-CPE = Thermoset Chlorinated Polyethylene

TP-CPE = Thermoplastic Chlorinated Polyethylene

XLPE = Cross Linked Polyethylene

LLDPE = Linear Low Density Polyethylene

Decimal equivalents of one inch

Table 9-2

8ths	16ths	32nds	64ths	Decimal
—	—	—	1	.015625
—	—	1	2	.03125
—	—	—	3	.046875
—	1	2	4	.0625
—	—	—	5	.078125
—	—	3	6	.09375
—	—	—	7	.109375
1	2	4	8	.125
—	—	—	9	.140625
—	—	5	10	.15625
—	—	—	11	.171875
—	3	6	12	.1875
—	—	—	13	.203125
—	—	7	14	.21875
—	—	—	15	.234375
2	4	8	16	.25
—	—	—	17	.265625
—	—	9	18	.28125
—	—	—	19	.296875
—	5	10	20	.3125

Useful Identities, Equations and Conversion Factors

1 mil = 0.001"

1 circular mil = (1 mil)²

Area of a circle = πr^2 or $\pi D^2/4$

where,

$\pi = 3.1416$

r = radius

D = diameter

1 mm = 39.4 mils

1 mile = 5280 ft

1 km = 0.6214 miles

1 km = 3281 ft

1 mile = 1.609 km

1 inch = 25.4 mm

1 meter = 3.281 ft

1 meter = 39.37 inches

1 ton (US) = 2000 lbs

To Convert	Multiply by	To Obtain
mils	0.0254	millimeters
circular mils	5.07×10^{-4}	square millimeters
inches	1.0×10^3	mils
inches	25.4	millimeters
feet	3.048×10^{-4}	kilometers
miles	1.609	kilometers
meters	3.281	feet
kilometers	0.6214	miles
kilometers	3.281×10^3	feet
pounds	0.4536	kilograms
pounds	4.448	Newtons (joules/meter)
pounds/ft	1.488	kilograms/meter
tons (US)	0.9078	tons (metric)
psi	0.00689	megapascals (Mpa)
volts/mil	0.03937	kV/mm
ohms/1000 ft	3.28	ohms/km
gigaohms - 1000 ft	305	gigaohms-meter

Temperature conversion table

Table 9-3

TO CONVERT DEGREES		
To C	F or C	To F
-65.	-85	-121
-62.22	-80	-112
-59.45	-75	-103
-56.67	-70	-94
-53.89	-65	-85
-51.11	-60	-76
-48.34	-55	-67
-45.56	-50	-58
-42.78	-45	-49
-40.	-40	-40
-37.22	-35	-31
-34.44	-30	-22
-31.67	-25	-13
-28.89	-20	-4
-26.11	-15	5
-23.33	-10	14
-20.56	-5	23
-17.78	0	32
-15.	5	41
-12.22	10	50
-9.44	15	59
-6.67	20	68
-3.89	25	77
-1.11	30	86
1.67	35	95
4.44	40	104
7.22	45	113
10.	50	122
12.78	55	131
15.56	60	140
18.33	65	149
21.11	70	158
23.89	75	167
26.67	80	176
29.44	85	185
32.22	90	194
35.	95	203
37.78	100	212
40.56	105	221
43.33	110	230
46.11	115	239
48.89	120	248
51.67	125	257
54.44	130	266
57.22	135	275
60.	140	284
62.78	145	293
65.56	150	302
68.33	155	311
71.11	160	320
73.89	165	329
76.67	170	338
79.44	175	347
82.22	180	356
85.	185	365
87.78	190	374
90.56	195	383
93.33	200	392
96.11	205	401
98.89	210	410
101.67	215	419
104.44	220	428
107.22	225	437
110.	230	446
112.78	235	455
115.56	240	464
118.33	245	473
121.11	250	482
123.89	255	491
126.67	260	500
129.44	265	509
132.22	270	518
135.	275	527

Miscellaneous Information

Equivalents of sq. mm, sq. in. and circular mils

Table 9-4

Sq. mm	Sq. in.	Cir. mils	AWG (C.M.)	Sq. mm	Sq. in.	Cir. mils	AWG (C.M.)	Sq. mm	Sq. in.	Cir. mils	AWG (C.M.)
1000	1.550	1974000		95	0.1472	187530		9.5	0.01472	18753	
975	1.511	1924700		90	0.1395	177660		9.0	0.01395	17766	
950	1.472	1875300		85	0.1317	167790		8.5	0.01317	16779	
925	1.434	1826000		80	0.1240	157920	3/0(167800)	8.0	0.01240	15792	8 (16510)
900	1.395	1776600		75	0.1163	148050		7.5	0.01163	14805	
875	1.356	1727300		70	0.1085	138180		7.0	0.01085	13818	
850	1.317	1677900		65	0.1008	128310	2/0(133100)	6.5	0.01008	12831	9 (13090)
825	1.279	1628600		60	0.0930	118440		6.0	0.00930	11844	
800	1.240	1579200		55	0.0853	108570		5.5	0.00853	10857	
775	1.201	1529900		50	0.0775	98700	1/0(105600)	5.0	0.00775	9870	10 (10380)
750	1.163	1480500		45	0.0698	88830		4.75	0.00736	9377	
725	1.124	1431200		40	0.0620	78960	1 (83690)	4.50	0.00698	8883	
700	1.085	1381800		35	0.0542	69090		4.25	0.00659	8390	
675	1.046	1332500		30	0.0465	59220	2 (66360)	4.0	0.00620	7896	11 (8230)
650	1.008	1283100		25	0.0388	49350	3 (52620)	3.75	0.00581	7403	
625	0.969	1233800		20	0.0310	39480	4 (41740)	3.50	0.00542	6909	12 (6530)
600	0.930	1184400		19.5	0.0302	38490		3.25	0.00504	6416	
575	0.891	1135100		19.0	0.0294	37510		3.0	0.00465	5922	
550	0.853	1085700		18.5	0.0287	36520		2.75	0.00426	5429	
525	0.814	1036400		18.0	0.0279	35530		2.50	0.00388	4935	13 (5180)
500	0.775	987000		17.5	0.0271	34550		2.25	0.00349	4442	
475	0.736	937700		17.0	0.0264	33560		2.0	0.00310	3948	14 (4110)
450	0.698	888300		16.5	0.0256	32560	5 (33090)	1.75	0.00271	3455	15 (3260)
425	0.659	839000		16.0	0.0248	31580		1.50	0.00233	2961	16 (2580)
400	0.620	789600		15.5	0.0240	30600		1.25	0.00194	2468	17 (2050)
375	0.581	740300		15.0	0.0233	29610		1.0	0.00155	1974	
350	0.542	690900		14.5	0.0225	28620		0.9	0.00140	1777	18 (1620)
325	0.504	641600		14.0	0.0217	27640		0.8	0.00124	1579	
300	0.465	592200		13.5	0.0209	26650		0.75	0.00116	1481	
275	0.426	542900		13.0	0.0201	25660	6 (26240)	0.7	0.00109	1382	
250	0.388	493500		12.5	0.0194	24680		0.6	0.00093	1184	19 (1290)
225	0.349	444200		12.0	0.0186	23690		0.5	0.00075	987	20 (1029)
200	0.310	394800		11.5	0.0178	22700					
175	0.271	345500		11.0	0.0171	21710					
150	0.233	296100		10.5	0.0163	20730	7 (20820)				
125	0.1938	246800		10.0	0.0155	19740					
100	0.1550	197400	4/0 (211,600)								

Capacity of Reels, feet

Table 9-5

*Reel Code	2412	2418	2718	3018	3224	4024	4528	5032	5832	6636	7636	7848	8454
Drum	10	10	12	12	14	17	21	24	28	36	40	42	48
Wt. Reel (Lbs)	22	24	33	39	61	90	116	178	250	400	568	696	861
Max. Load (Lbs)	550	550	700	950	1500	2500	3500	4800	6500	7000	9000	9000	10000
Max. Overall Width (In)	15	21	21½	21½	28½	28½	32½	38	39½	43½	43½	56	62
CABLE O.D.													
.200	6401	9454	12341	16845	24920								
.250	4189	6331	7983	10685	15776	25253							
.300	2913	4370	5636	7530	11075	17337	24976						
.350	2053	3080	4068	5339	7979	12536	18489	25984					
.400	1572	2358	2919	4015	6016	9886	13872	19298	27681				
.450	1188	1806	2504	3258	4732	7604	10953	15210	21482	29143			
.500	964	1490	1890	2553	3733	6243	9025	12617	17314	23468			
.550	797	1235	1584	2194	3203	5101	7384	10574	14009	18909	27110		
.600	677	998	1297	1849	2768	4157	6009	8662	11674	15935	23381		
.650	531	813	1075	1585	2354	3609	5173	7062	10360	13999	18867		
.700	513	770	1017	1334	1964	3085	4622	6239	8691	1612	16877	23671	29336
.750	411	604	815	1101	1659	2681	3973	5448	7695	10353	14429	19931	24938
.800	393	589	666	932	1374	2297	3468	4824	6920	9144	12921	18163	22504
.850	303	466	646	907	1302	1937	2988	4109	5999	8196	11011	15117	18904
.900	285	451	626	749	1091	1901	2539	3551	5290	7285	9918	13522	17026
.950	290	435	492	724	1066	1635	2493	3501	4765	6417	8867	12249	15223
1.000	212	328	472	581	832	1526	2076	2976	4119	5594	7861	10781	13501
1.050			452	556	807	1285	2027	2819	3903	5332	7500	10439	12859
1.100			338	530	781	1244	1719	2435	3438	4727	6777	9286	11502
1.150			320	408	613	1024	1670	2377	2996	4010	5877	8189	10207
1.200			324	414	621	1039	1387	2018	2918	3913	5742	8072	9845
1.250					597	999	1341	1961	2505	3384	5094	7037	8852
1.300					571	798	1293	1632	2429	3291	4477	6247	7696
1.350					427	761	1043	1578	2351	3195	4350	5949	7567
1.400					432	771	1055	1523	1977	2712	4219	5826	7233
1.450						595	1010	1233	1903	2622	3653	5102	6365
1.500						602	964	1245	1923	2530	3527	4982	6234
1.550						568	796	1194	1582	2201	3151	4306	5419
1.600						574	756	1206	1598	2118	3034	4192	5294
1.650						539	764	1153	1528	2033	2915	4076	5167
1.700							426	623	899	1456	2049	2569	3463
1.750								729	907	1234	1658	2460	3489
1.800								541	861	1171	1670	2479	3380
1.850								545	868	1181	1593	2367	3269
1.900								550	875	1191	1604	2052	2836
1.950									514	653	1126	1525	1951
2.000									519	657	928	1265	1965
2.100									364	622	878	1205	1582
2.200										586	827	1143	1501
2.300										445	662	859	1418
2.400										416	618	868	1180
2.500											626	814	1107
2.600											580	822	1119
2.700											440	581	829
2.800											404	586	837
2.900												541	774
3.000												546	781
3.100												550	787
3.200												354	546
3.300												356	550
3.400													358
3.500													324
3.600													326
3.700													509
3.800													359
3.900													321
4.000													322
4.100													
4.200													
4.300													
4.400													
4.500													
4.600													
4.700													
4.800													

*NOTE:
 (1) Reel Code Signifies Head and Inside Traverse Dimensions e.g. 24" Head, 12" Traverse.
 (2) Arbor Hole is 3.062 inches for all sizes
 (3) These reels are intended for shipping rubber and Thermoplastic Insulated Wires and cables WITHOUT lead covering.

**Dimensions and capacities of
reels for wire and cables**

Table 9-6

Reel Code Number	4224	4824	5432	6434	6636	7236	7236
Flange Diameter, Inches	42	48	54	64	66	72	72
Traverse Width, Inches	26	24	32	34	36	36	36
Drum Diameter, Inches	18	24	26	32	36	40	40
Max. Overall Width, Inches	31	34	40	42	42	42	48
Approx. Capacity, Cubic Inches	16350	25600	37100	53100	63500	65000	85500
Arbor Hold, Inches	3	3	3	3	3	3	3

CABLE O.D.	REEL CAPACITY, feet							MIN. DRUM DIA. *
0.50	5800	9000	12000					↑ 16 ↓
0.60	4250	6000	8600					
0.70	3050	4300	5800	8800				
0.80	2150	3200	5000	7000	8000	8500	9200	
0.90	1650	2600	3800	5000	6200	7000	8100	
1.00	1200	1950	2900	4100	4900	5100	6800	
1.10	950	1600	2300	3300	4100	4200	5200	
1.20	900	1350	1830	2800	3300	3400	4400	
1.30	670	1200	1700	2300	2700	3000	3600	
1.40	640	980	1300	2100	2500	2550	3400	
1.50	460	900	1270	1800	2000	2100	2900	
1.60	440	730	980	1480	1800	1900	2400	
1.70	410	650	900	1350	1550	1600	2250	
1.80	380	500	850	1200	1500	1400	1900	
1.90	270	500	650	1075	1400	1350	1760	
2.00	250	470	620	1020	1100	1280	1650	
2.10			580	950	1050	940	1350	
2.20			550	720	900	890	1250	
2.30			550	720	720	840	950	
2.40			360	680	715	830	950	
2.50			360	520	680	700	900	
2.60			340	480	675	565	900	
2.70					500	530	640	14
2.80					450	525	640	14
2.90					420	490	600	12
3.00					415	485	600	12
3.10					400	485	550	12
3.20					385	280	550	12
3.30					350	280	390	12
3.40						260		
3.50						260		
3.60						260		
3.70						230		
3.80						230		
3.90						230		
4.00						230		

*NOTE: As a multiple of the outside diameter of cable.
Minimum clearance under lags shall be 1 inch or 1 cable diameter, whichever is greater.

Dimensions and capacities of reusable reels for wires and cables

Table 9-6

Reel Code Number	7836	7848	9054	9654
Flange Diameter, Inches	78	78	90	96
Traverse Width, Inches	36	48	54	54
Drum Diameter, Inches	40	48	48	56
Max. Overall Width, Inches	48	62	68	68
Approx. Capacity, Cubic Inches	109600	119600	216000	226000
Min. Arbor Hole, Inches	3	3	3	3

CABLE O.D.	REEL CAPACITY, feet				Min. Drum Dia. *
0.50					
0.60					
0.70					
0.80	12500	14000			
0.90	10500	11400			
1.00	8500	9500	15500	17200	
1.10	7000	7150	13500	14000	
1.20	5700	6000	10600	12000	
1.30	5000	5350	9200	10000	
1.40	4200	4500	7800	8500	
1.50	3500	3850	6800	7500	
1.60	3200	3400	5900	6300	
1.70	2900	2950	5600	6000	
1.80	2500	2650	4600	4800	
1.90	2400	2250	4000	4200	
2.00	1950	2100	3750	4000	16
2.10	1900	2000	3650	3600	
2.20	1700	1600	3000	3100	
2.30	1400	1400	2900	3000	
2.40	1400	1400	2400	2800	
2.50	1370	1350	2250	2300	
2.60	1100	1040	2150	2200	
2.70	1050	960	2100	2100	
2.80	1000	960	1800	2000	
2.90	950	880	1700	1600	
3.00	780	880	1650	1550	
3.10	780	650	1600	1450	
3.20	730	580	1300	1450	
3.30	730	580	1200	1400	
3.40		530	1200	1200	
3.50		530	1100	1100	
3.60		530	1050	1100	
3.70		480	1000	950	14
3.80		480	850	950	
3.90		300	850	900	
4.00		300	775	900	2